

3 MILLION CYCLE ROTATIONAL LIFE

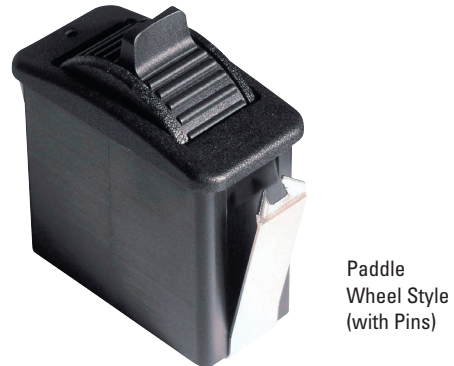

Knurled
Wheel Style
(with Wires)



Paddle
Wheel Style
(with Pins)

The HTW Hall Effect Proportional Output Thumbwheel is a spring-return-to-center, single axis thumbwheel with an actuator that provides linear change in voltage output in either direction from the center. Available with eight output options, including increasing and decreasing voltage output from the center position to the full travel position and single or dual (redundant) outputs. The HTW snaps into a 1.47" x 0.710" panel opening with rocker switch style mounting. A durable switch providing three million cycle rotational life, sealed to IP68S and excellent EMI / RFI immunity.

Features:

- 8 output options
- Spring-return-to-center single axis actuator
- Snaps into 1.47" x 0.710" panel opening
- Rocker switch style mounting
- 3 million cycle rotational life
- Electronics sealed to IP68S
- Excellent EMI/RFI immunity
- Detent options available
- Tighter center tolerance options
- RoHS/WEEE/Reach compliant

Standard Characteristics/Ratings:				
MECHANICAL:				
Mechanical Life: 3,000,000 full forward to full back				
Mechanical Detent Cycle Life Per Detent: 100,000 (detent @ +/- 21°, full travel is +/- 30° max)				
Max Allowable Radial Load: 30.0 lbs.				
ELECTRICAL RATINGS: Rated at Vcc = 5V @ 25°C Load = 1mA (4.7KΩ)				
Electrical	Units	Min	Typ	Max
Supply Voltage	VDC	4.50	5	5.50
Output Voltage Tolerance at Center (A, B, C, D, E, F, G and H)	VDC @ 5V Vcc	-0.15	N/A	+0.15
Output Voltage Tolerance at Center (J, K, L, M, N and P)	VDC @ 5V Vcc	-0.10	N/A	+0.10
Output Voltage Tolerance at Center (for detent version A only)	VDC @ 5V Vcc	-0.25	N/A	+0.25
Output Voltage Tolerance Full Travel	VDC @ 5V Vcc	-0.25	N/A	+0.25
Supply Current Options A & D B=0, Vcc=5V, Iout=0	mA	N/A	N/A	10
Supply Current For all Other Options B=0, Vcc=5V, Iout=0	mA	N/A	N/A	20
Reverse Voltage Protection:	-5VDC max			
ELECTRONICS:				
Seal Integrity:	Electronics IP68S			
ENVIRONMENTAL:				
Operating Temp Range:	-40°C to +85°C			
Humidity:	96% RH, 70°C, 96 hours			
Vibration:	Per MIL-810F minimum integrity			
EMI:	Withstand per SAE J1113			
RFI:	Withstand per SAE J1113			
MATERIALS:				
Button:	Thermoplastic			
Bezel:	Thermoplastic			
Snap Arms:	Stainless steel			
Wires:	18 AWG			

PROPORTIONAL OUTPUT THUMBWHEEL

3 MILLION CYCLE ROTATIONAL LIFE

HTW PART NUMBER CODE

HTW	-	X	X	X	X	X	X	X	X
Travel	Output 1	Output 2	Operating Force	Button Style	Termination	Bezel Color	Button Color	Detent (if required)*	
1. +/- 40°	A. 2.5 +/- 2.0VDC	NONE	1. 5.0 oz.	1. Knurled Wheel	A. 18 AWG Wires 18.3" Long, Stripped Ends	1. Red	1. Red	A. Spring return center +/- 21°. 12 oz detent at end of travel, both directions**	
2. +/- 30°	B. 2.5 +/- 2.0VDC	2.5 +/- 2.0VDC		2. Paddle Wheel	B. 0.025" SQ. Pins	2. Black	2. Black		
	C. 2.5 +/- 2.0VDC	2.5 +/- 2.0VDC				3. Orange	3. Orange		
	D. 2.5 +/- 1.5VDC	NONE				4. Yellow	4. Yellow		
	E. 2.5 +/- 1.5VDC	2.5 +/- 1.5VDC				5. Green	5. Green		
	F. 2.5 +/- 1.5VDC	2.5 +/- 1.5VDC				6. Blue	6. Blue		
	G. 1.0 - 4.0VDC	1.0 - 4.0VDC				7. Violet	7. Violet		
	H. 0.5 - 4.5VDC	0.5 - 4.5VDC				8. Gray	8. Gray		
	J. 2.5 +/- 2.0VDC	NONE***				9. White	9. White		
	K. 2.5 +/- 2.0VDC	2.5 +/- 2.0VDC***							
	L. 2.5 +/- 2.0VDC	2.5 +/- 2.0VDC***							
	M. 2.5 +/- 1.5VDC	NONE***							
	N. 2.5 +/- 1.5VDC	2.5 +/- 1.5VDC***							
	P. 2.5 +/- 1.5VDC	2.5 +/- 1.5VDC***							

* Detented switch full travel is ±30° max. Detented switches reach full output before engaging detents.

** Only available with Travel option 2.

*** Options J, K, L, M, N and P are identical to options A, B, C, D, E and F respectively, except with a tighter center tolerance.

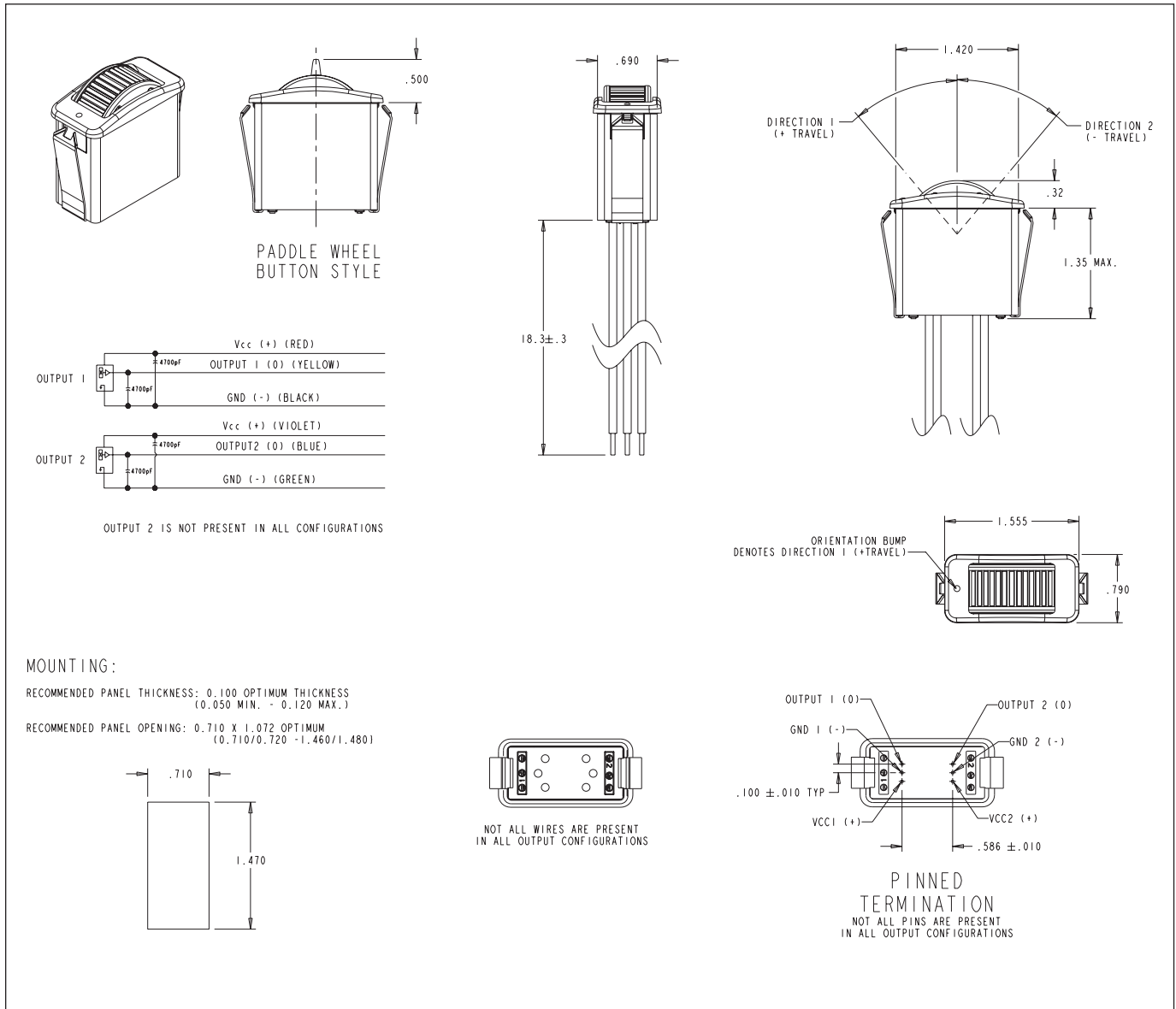

HALL EFFECT

3 MILLION CYCLE ROTATIONAL LIFE

OPTION A & J

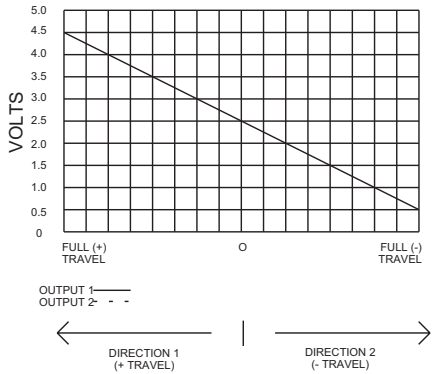

OPTION B & K

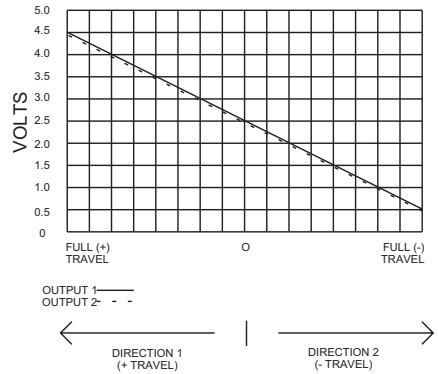

OPTION C & L

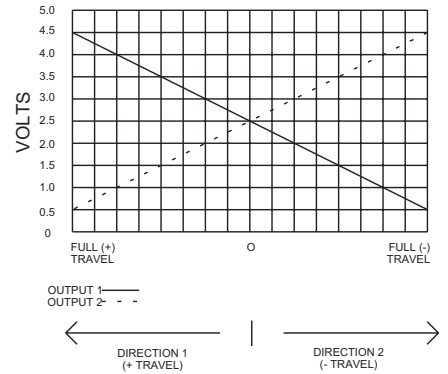

OPTION D & M

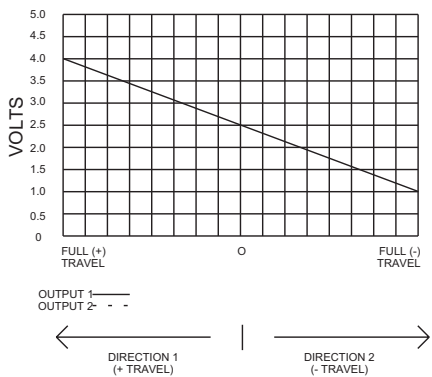

OPTION E & N

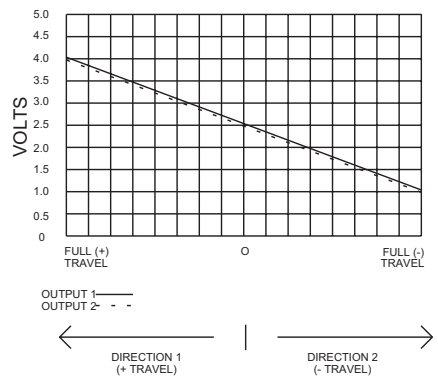

OPTION F & P

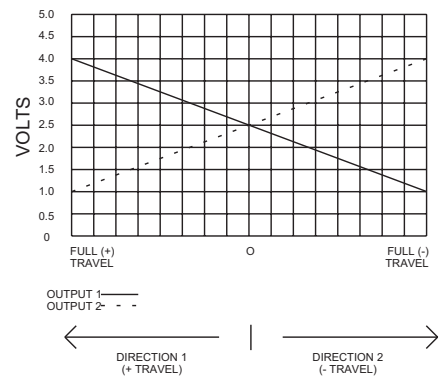

OPTION G

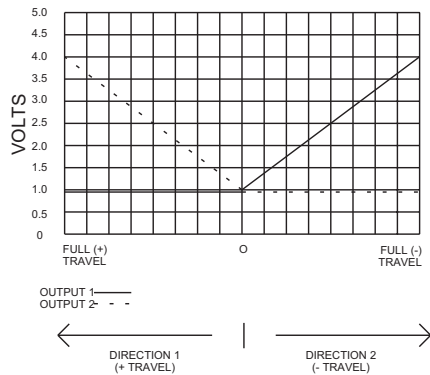

OPTION H

