



WORLD PRODUCTS INC.

THYRISTORS



WORLD PRODUCTS INC. || 19654 Eighth Street East || P.O. Box 517 || Sonoma, CA 95476
Phone: (707) 996.5201 || FAX: (707) 996.3380 || www.worldproducts.com || sales@worldproducts.com
©2013 World Products Inc.



THIS PAGE WAS INTENTIONALLY LEFT BLANK.

Table of Contents

Definitions 2

Features 3

Selection Guide 3

Maximum Thermal Ratings 4

Thermal Characteristics 4

Electrical Characteristics Definition 4

Mechanical Data 5

Solderability 5

Maximum Surge Ratings 6

Electrical Characteristics 7

Device Part Marking 7

Order and Packing Information 8

Rating and Characteristic Curves 9

Circuit Examples 11

World Products, LLC, specializing in protection components for telecommunication and AC and DC circuits, is proud to feature World Products complete line of Thyristors.

The main features of these Thyristors are:	Providing the following benefits:
<ul style="list-style-type: none"> • Bidirectional transient voltage protection. • Nanosecond clamping response. • No performance degradation under service life. • Glass passivated junction. 	<ul style="list-style-type: none"> • A range of voltage protection levels. • Primary or secondary protection levels. • Highest level of quality and reliability. • Low cost auto-assembly.

Definitions

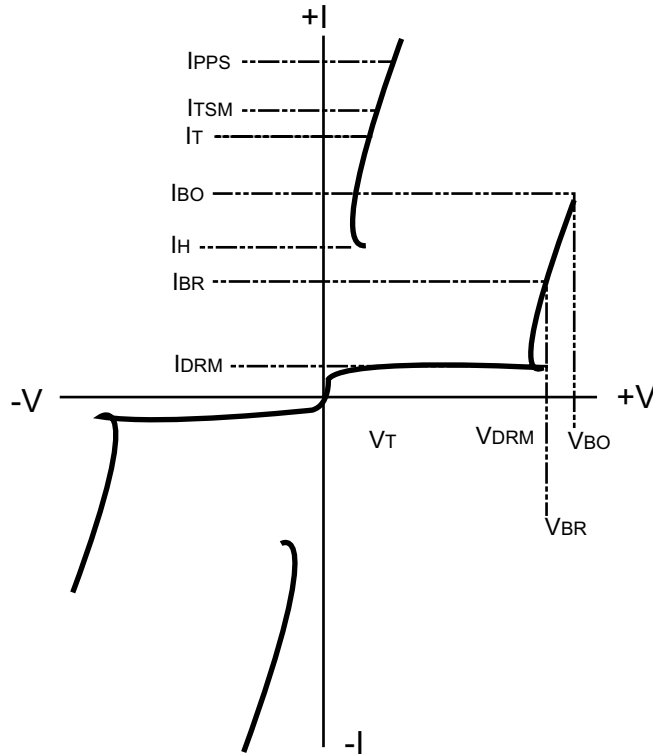

Symbol	Characteristic	Value
V_{BO}	Max Breakover Voltage	The maximum voltage across the device in or at breakdown measured under a specified voltage and current rate of rise.
V_{BR}	Min Breakover Voltage	The minimum voltage at which the device switch-on begins and significant current flows.
I_{BO}	Breakover Current	The instantaneous current flowing at the breakover voltage. (V_{BO})
I_H	Holding Current	The minimum current required to maintain the device in the on-state.
I_T	On-state Current	The current through the device in the on-state condition.
V_T	On-state Voltage	The voltage across the device in the on-state condition at a specified current. (I_T)
V_{DRM}	Rated Repetitive Peak Off-state Voltage	Rated maximum (peak) continuous voltage that may be applied in the off-state condition.
I_{DRM}	Repetitive Peak Off-state Current	The maximum (peak) value of the current that results from the application of (V_{DRM})
I_{PPS}	Non-Repetitive Peak Pulse Current	Rated maximum value of peak impulse current of specified amplitude and waveshape that may be applied without damage to the device under test.
I_{TSM}	Non-Repetitive Surge Peak On-state Current	Rated maximum value of AC current, at a given frequency, which may be applied for specified time or number of cycles.
di/dt	Critical Rate of Rise of On-state Current.	Rated value of the rate of rise of current that the device can withstand without damage.
dv/dt	Critical Rate of Rise of Off-state Voltage.	The maximum rate of rise of voltage (below V_{DRM}) that will not cause switching from the off-state to the on-state

Features

- Protects by Limiting voltages and shunting surge currents away from sensitive circuits.
- Designed for telecommunications applications such as line cards, modems, PBX, FAX, LAN, VHDSL.
- Helps meet standards such as GR1089, ITU K.20, IEC950, UL1459&50, FCC part 68.
- Low capacitance, High surge (C, D, E rating available), precise voltage limiting, Long life.
- RoHS compliant with Directive 2002/95/EC of the European Parliament and of the Council of 27 January 2003 on the restriction of the use of certain hazardous substances in electrical and electronic equipment (RoHS Directive) and comply to a maximum concentration value of 0.1% by weight in homogeneous materials for lead (Pb), mercury, hexavalent chromium, polybrominated biphenyls (PBB) and polybrominated diphenyl ethers (PBDE) and of 0.01% weight in homogeneous materials for cadmium.

Selection Guide

Follow these steps to select the proper Thyristor surge protector for your application:

1. Define the operating parameters for the circuit:
 - Ambient operating temperature range
 - Maximum telephone line operating current (highest battery and shortest copper loop)
 - Maximum operating voltage: (Maximum DC bias + peak ringing voltage)
 - Maximum surge current
 - System voltage damage threshold
2. Select device with an off-state voltage rating (V_{DRM}) above the maximum operating voltage at the minimum operating temperature.
3. Select surge current ratings (I_{PPS} and I_{TSM}) > those which the application must withstand
4. Verify that the minimum holding current of the device at the maximum ambient temperature is above the maximum DC current of the system.
5. Verify that the maximum breakover voltage of the device is below the system damage threshold.
6. Verify that the circuit's ambient operating temperatures are within the device's operating temperature range.
7. Verify that the device's dimensions fit the application's space considerations.
8. Independently evaluate and test the suitability and performance of the device in the application.

Maximum Thermal Ratings

Rating	Symbol	Value	Unit
Storage Junction Temperature Range	TSTG	-55 to 150	°C
Operating Junction Temperature Range	TJ	-40 to 150	°C

Notes:

PCB board mounted on minimum foot print.

Thermal Characteristics

Characteristic	Symbol	Value	Unit
Thermal Resistance Junction to leads TL on tab adjacent to plastic. Both leads soldered to identical pad sizes.	R θ JL	Max. 20	°C / W

Notes:

The junction to lead thermal resistance represents a minimum limiting value with both leads soldered to a large near-infinite heatsink. The junction to ambient thermal resistance depends strongly on board mounting conditions and typically is 3 to 6 times higher than the junction to lead resistance. The data shown is to be used as guideline values for preliminary engineering.

Electrical Characteristics Definition

(Tc = 25°C unless otherwise noted)

Parameters	Test Conditions	Symbol	Min.	Max.	Unit
Repetitive Peak Off-State Current	VD = rated VDRM	IDRM		5	μA
Breakover Current	f = 60 Hz, ISC = 1Arms, Vac = 1 KVRms, RL = 1Kohm, 1/2 AC cycle	IBO	.	800	mA
Holding Current	10/1000μs waveform, ISC = 10A, VOC = 62 V, RL = 400 ohms	IH	150		mA
On-State Voltage	IT = 1 A, TW = 300μs, 1 pulse	VT	.	3.5	V

Notes:

Specific IH values are available by request.

Mechanical Data

- Case: JEDEC DO-214AA molded plastic
- Polarity: Bi-directional Standard packaging: 12mm tape (EIA-481)
- Weight: 0.003 ounce, 0.093 gram

SMB / DO-214AA

Unit: inch (mm)

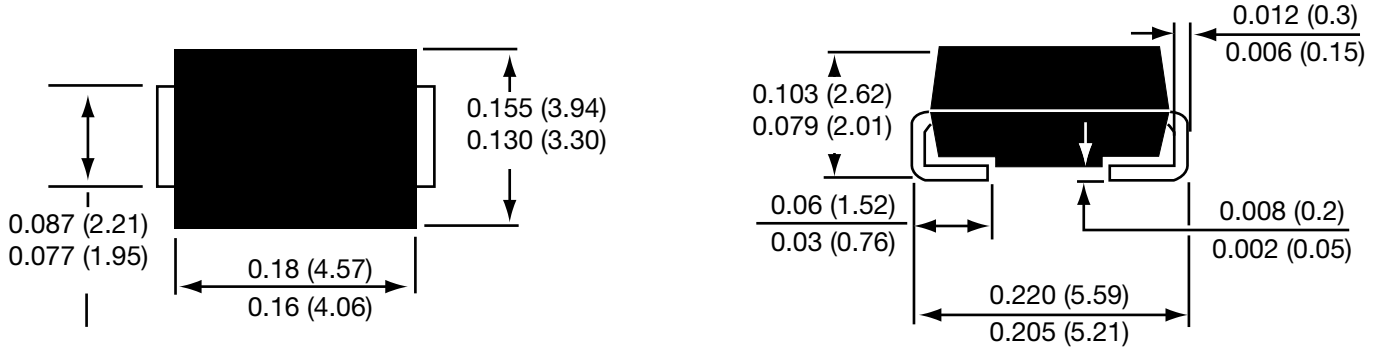

Solder Pads

Unit: inch (mm)

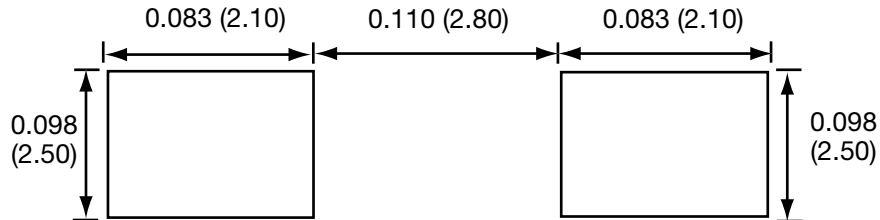

Solderability

Military Standard 202G, Method 208H

Heat Resistance of Solder

Standard Temperature Profile for Lead-free Solder

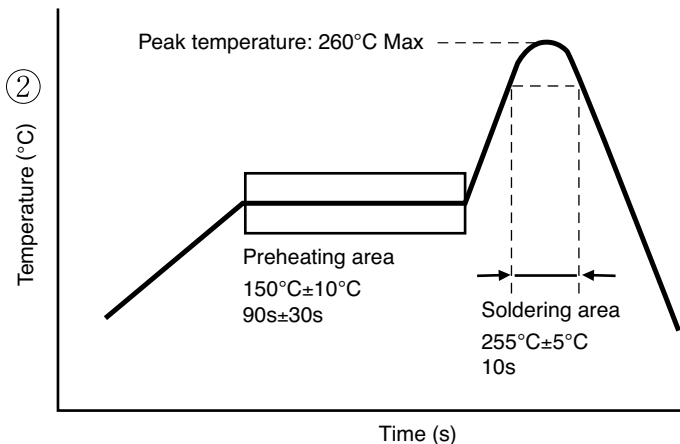

Note: For Lead-free solder, the maximum temperature during mounting processes will be 260°C for both re-flow and flow soldering processes.

Maximum Surge Ratings

(T_J = 25°C unless otherwise noted)

Rating	Non-Repetitive Peak Pulse Current				
Symbol	IPPS				
Short-Circuit Current Wave	2/10 μs	8/20 μs	10/160 μs	10/560 μs	10/1000 μs
Open-Circuit Voltage Wave	2/10 μs	1.2/50 μs	10/160 μs	10/560 μs	10/1000 μs
C	200 A	150 A	100 A	70 A	50 A
D	300 A	250 A	150 A	100 A	80 A
E	500 A	400 A	250 A	200 A	100 A
Notes	(1,2,4,5,6)				

Notes:

1. Thermal accumulation between successive surge tests is not allowed.
2. The device under test initially must be in thermal equilibrium with T_J = 25°C.
3. Test at 1 cycle, 60 Hz.
4. Surge ratings are non-repetitive because instantaneous junction temperatures may exceed the maximum rated T_J. Nevertheless, devices will survive many surge applications without degradation. Surge capability will not degrade over a device's typical operating life.
5. Adjust the surge generator for optimum current-wave accuracy when both voltage and current wave specifications cannot be exactly met. The current wave is more important than the voltage wave for accurate surge evaluation.
6. The waveform is defined as A/B ms where:
 A: (Virtual front time) = 1.25 X Rise time = 1.25 X (T_b - T_a)
 B: (Duration time to 50% level of IPPS) = T₁ - T₀

Maximum Rated Surge Waveform

Waveform	Standard	I _{pp} (A)		
		C type	D type	E type
2 / 10μs	GR-1089-CORE	200	300	500
8 / 20μs	IEC61000-4-5	150	250	400
10 / 160μs	FCC Part 68	100	150	250
10 / 700μs	ITU-T K20/21	60	90	160
10 / 560μs	FCC Part 68	70	100	200
10 / 1000μs	GR-1089-CORE	50	80	100

Waveform of Surge

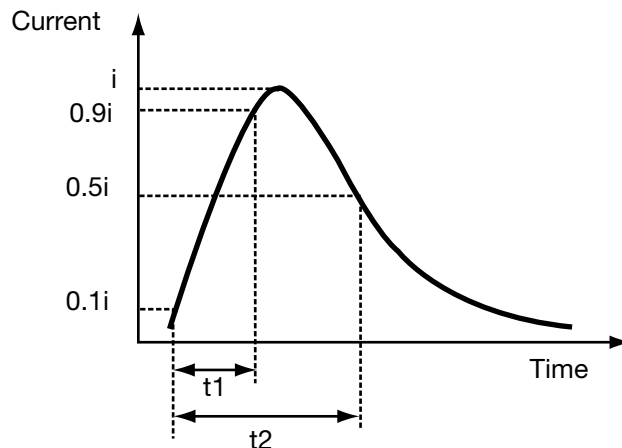

Electrical Characteristics

Part Number	Rated Repetitive Peak Off-State Voltage	Breakover Voltage	On-state Voltage	Repetitive Peak Off-State Current	Breakover Current	Holding Current	Off-State Capacitance (f = 1MHz, 1.0V _{rms})		
	Max.	Max.	Max.	Max.	Max.	Min.	Typ.		
	V _{DRM}	V _{BO@I_{BO}}	V _{T@1A}	I _{DRM}	I _{BO}	I _H	C _o @ 2Vdc Reverse Bias		
	V	V	V	μA	mA	mA	pF		
Series	C, D or E						C	D	E
WPSCDS-058□	58	77	3.5	5.0	800	150	100	140	200
WPSCDS-065□	65	88	3.5	5.0	800	150	100	140	200
WPSCDS-075□	75	98	3.5	5.0	800	150	100	140	200
WPSCDS-090□	90	130	3.5	5.0	800	150	60	90	120
WPSCDS-120□	120	160	3.5	5.0	800	150	60	90	120
WPSCDS-140□	140	180	3.5	5.0	800	150	60	90	120
WPSCDS-160□	160	220	3.5	5.0	800	150	60	90	120
WPSCDS-190□	190	265	3.5	5.0	800	150	40	60	80
WPSCDS-220□	220	300	3.5	5.0	800	150	40	60	80
WPSCDS-275□	275	350	3.5	5.0	800	150	40	60	80
WPSCDS-320□	320	400	3.5	5.0	800	150	40	60	80
Notes	(1,3)	(3,5,6)	(3)	(3)	(3)	(2,3)	(3)	(3)	(3)

□ - Part Number Suffix:
 Current Rating Code – C, D, E.
 If Pb-Free is required add suffix “F” after suffix code C, D, or E.
 If Halogen Free is required, add “X” after “F” following suffix code C, D, or E.

- Notes:**
1. Specific V_{DRM} values are available by request.
 2. Specific I_H values are available by request.
 3. All ratings and characteristics are at 25°C unless otherwise specified.
 4. V_{DRM} applies for the life of the device. I_{DRM} will be in spec during and following operation of the device.
- All parts are UL Recognized File # 135015.



SMD/DO-214AA

Device Part Marking

Example Part Number: WPSCDS-058C

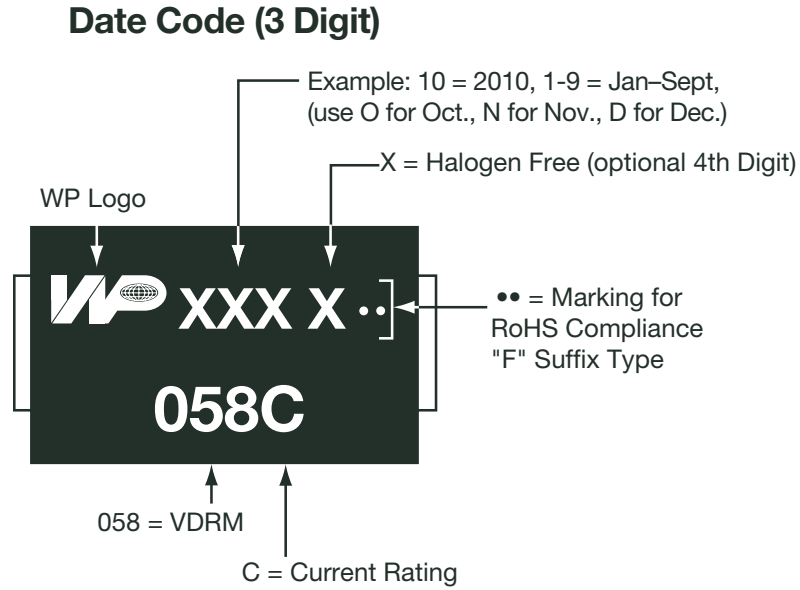

Order and Packing Information

Device	Packing	Min. Order Qty.	Order As	Remark
WPSCDS-xxx	13" Tape & Reel	3,000 pcs	WPSCDS-xxxT	Standard Packing
	Bulk		WPSCDS-xxxB	

Rating and Characteristic Curves

C Series

Typical Capacitance vs. Rated Repetitive Off-state Voltage

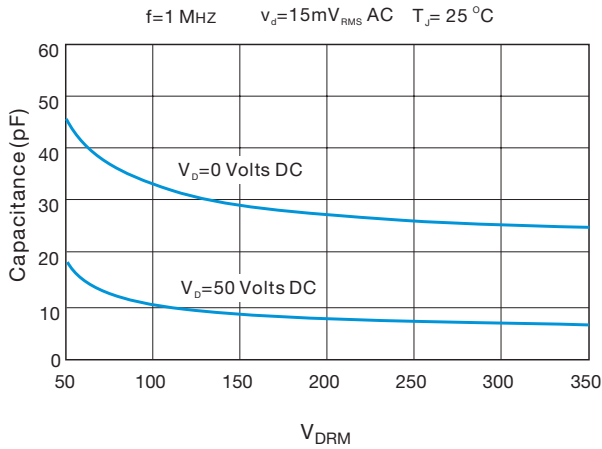

Typical Capacitance vs. Off-state Voltage

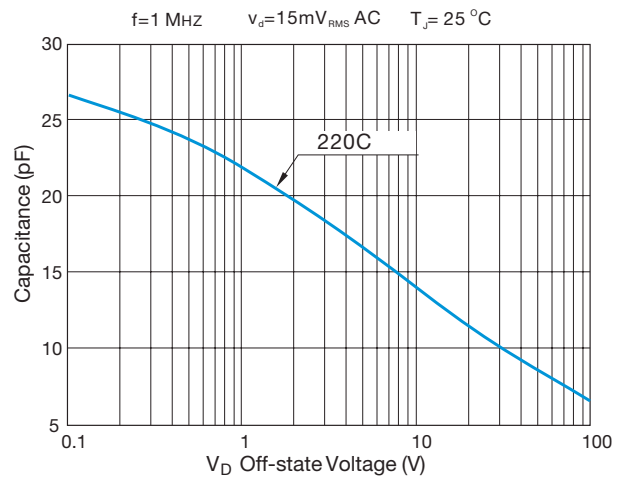

D Series

Typical Capacitance vs. Rated Repetitive Off-state Voltage

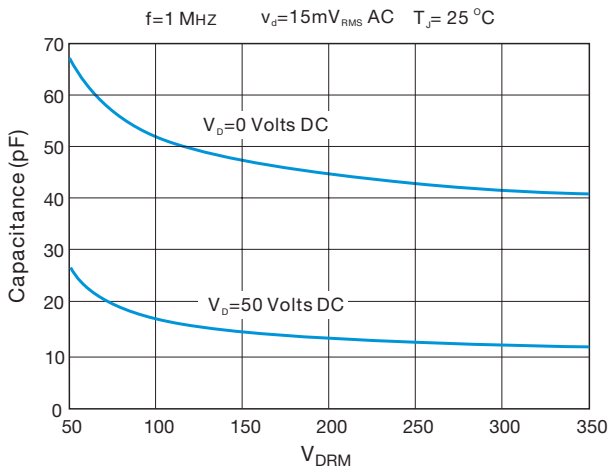

Typical Capacitance vs. Off-state Voltage

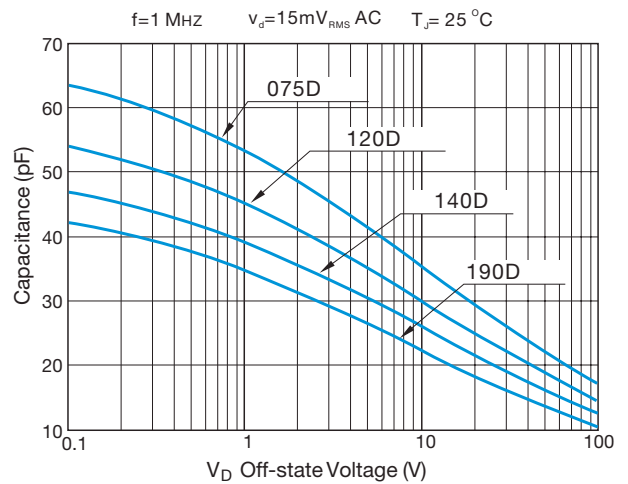

E Series

Typical Capacitance vs. Rated Repetitive Off-state Voltage

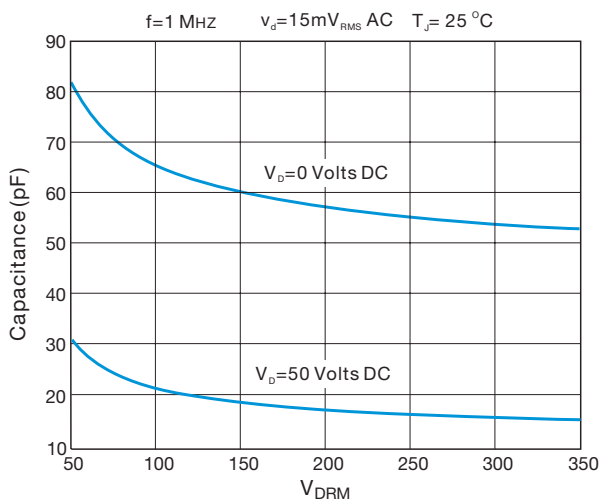

Typical Capacitance vs. Off-state Voltage

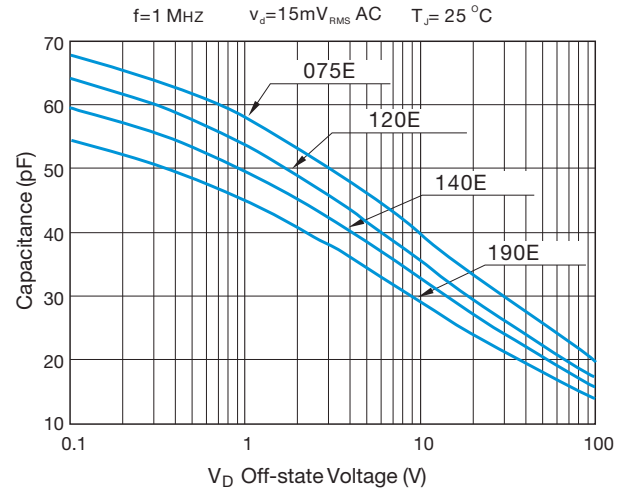

Rating and Characteristic Curves (continued)

C, D, E Series

Typical Off-State Current vs. Junction Temperature

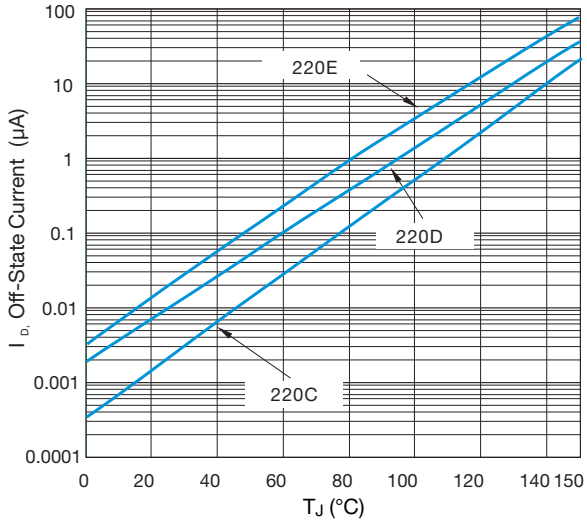

Typical Holding Current

10A, 10/1000 microseconds

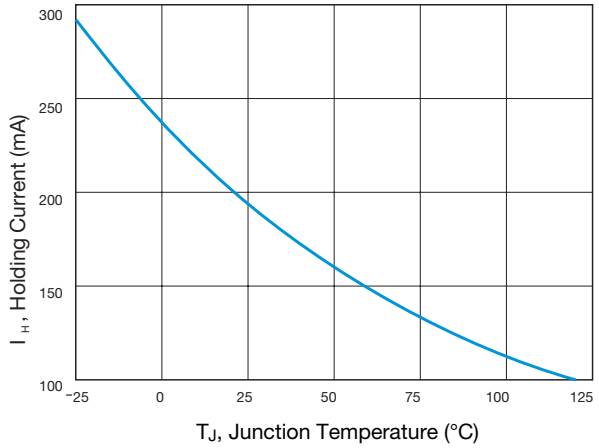

Typical Holding Current Temperature Coefficient

10A, 10/1000 microseconds

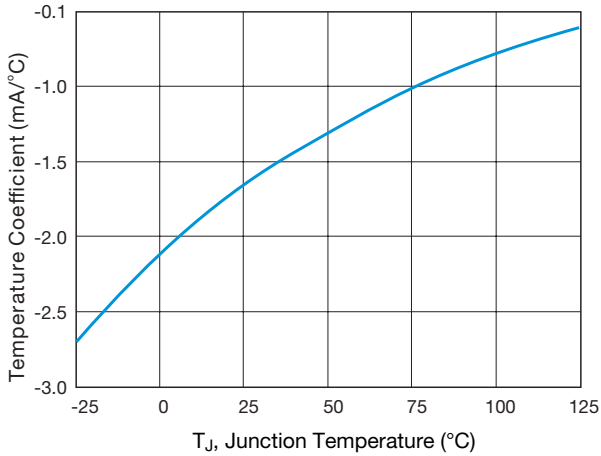

Typical Holding Current Temperature Coefficient

10A, 10/1000 microseconds

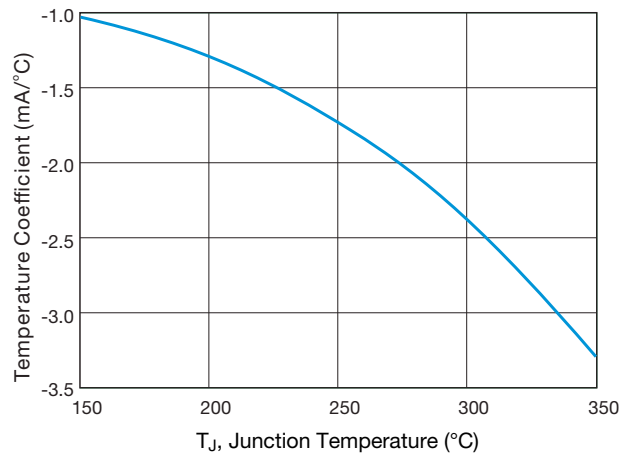

Temperature Coefficient of V_{DRM}

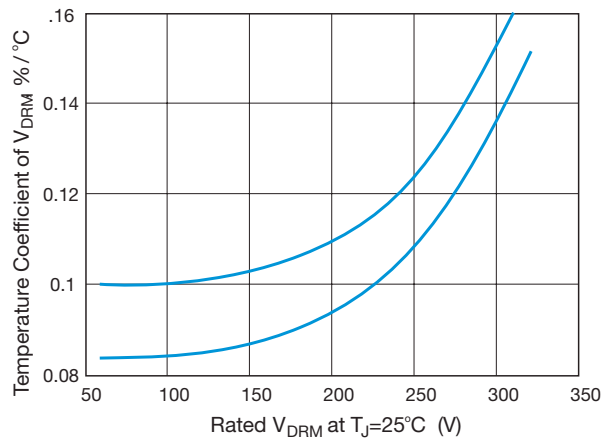

Circuit Examples

PABX Protection

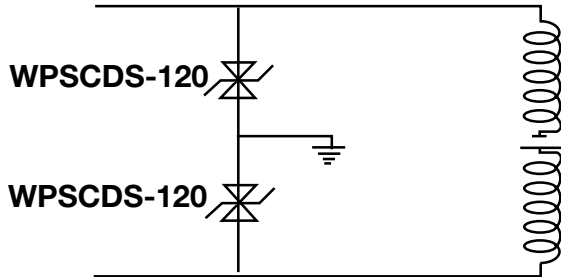

DC Supply

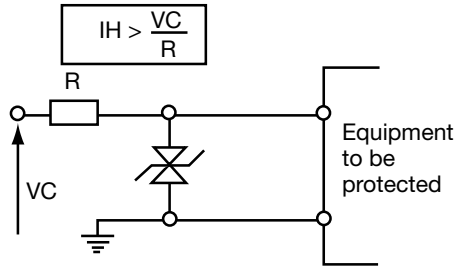

SLIC Protection

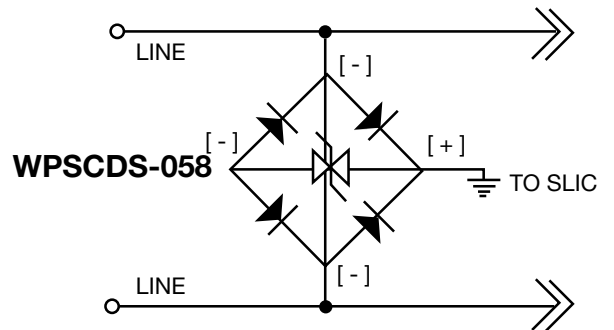
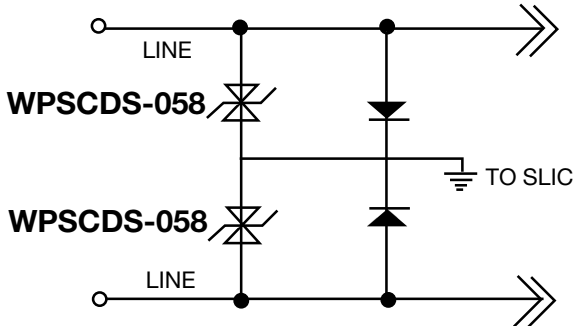

Complete PC Board Operation Protection

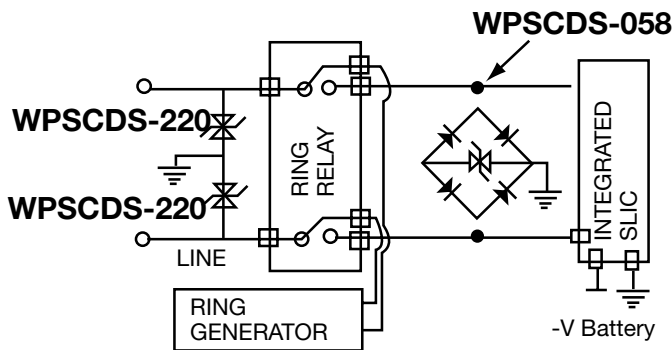

DISCLAIMER: The names of the products and the specifications in this catalog are subject to change without notice for the sake of improvement. World Products, LLC also reserves the right to discontinue any of these products. The products in this catalog are intended for use in ordinary electronic products. If any of these products are to be used in special applications requiring extremely high reliability, where product defects might pose a safety risk, please consult World Products, LLC. Though World Products, LLC has taken all possible precautions to ensure the quality and reliability of its products, improper use of products may result in bodily injury, fire, or similar accident. If you have any questions regarding the use of the products in question, please consult World Products, LLC. Please be advised that World Products, LLC accepts no responsibility for any infraction by users of World Products, LLC products on third party patents or industrial copyrights.

THIS PAGE WAS INTENTIONALLY LEFT BLANK.