

ENVIRONMENTALLY SEALED TOGGLE

The T9 Toggle Switch is an ideal switch for demanding applications. Qualified to MIL-DTL-3950, this high performance switch is a logical choice for use in environments where sealing and resistance to shock and vibration are required. The T9 is particularly suitable for applications in military, off-highway, aviation, commercial and industrial equipment. This compact, environmentally sealed switch is available in single and double pole configurations with a lever lockout option. Circuitry configurations include two or three positions with many combinations of OFF-ON in momentary and maintained action including ON-ON-ON.

Features:

- Qualified to MIL-DTL-3950
- Commercial version is sealed per IP68S
- Lever lockout option available
- Maintained & momentary toggle action
- Optional panel seal
- RoHS compliant
- Black matte finish available. Contact factory.

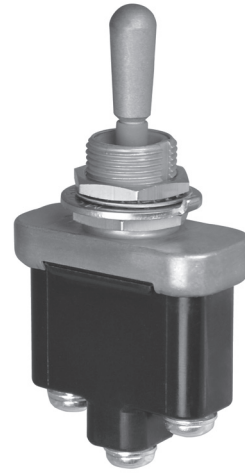

Standard Characteristics/Ratings:

ELECTRICAL RATINGS:	See Product Family Table
Electrical Life:	20,000 cycles
Mechanical Life:	40,000 cycles
Seal:	IP68S and per MIL-DTL-3950
Operating Temp Range:	-65°C to +71°C
MATERIALS:	
Toggle:	Stainless steel, passivated
Bushing & Cover:	Aluminum, clear anodized or zinc alloy
Case:	Thermoset plastic
Terminal Hardware:	Included
Mounting Hardware:	Hardware is not installed on switches. Hex nuts, MS35333-136 lockwasher, MS25081-C4 keyway washer, 0.138-32 UNC-2A screw with lockwasher (as required).

Ihr offizieller Vertriebspartner



ALDERS[®]
Indicate. Control. Connect.

ALDERS electronic GmbH
Arnoldstraße 19
47906 Kempen

+49 2152 8955-0
vertrieb@alders.de / www.alders.de

T9 PART NUMBER CODE

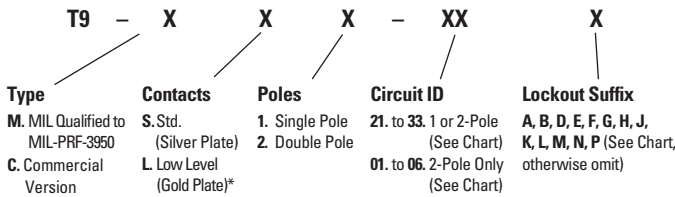

* Available in commercial only.

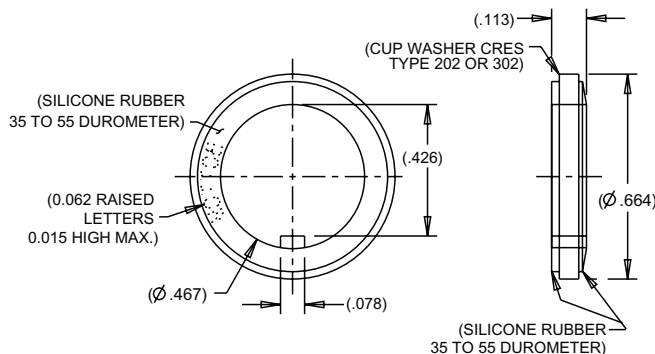

Optional Panel Seal P/N C710196, MIL-DTL- 5423/16

Lever Lockout Configuration Codes

Figures A thru P are schematics to illustrate lockout configurations and momentary positions. They do not represent details of construction.

- A** Locked in all three positions
- B** Locked in Center and Keyway Side position
- D** Locked out of Center position
- E** Locked in Center position
- F** Locked in Opposite Keyway position
- G** Locked in Keyway Side position
- H** Locked out of Center and Keyway Side Position
- J** Locked out of Center and Opposite Keyway position
- K** Locked in Center and Opposite Keyway position
- L** Locked out of Keyway Side position
- M** Locked out of and into Opposite Keyway position
- N** Locked out of Opposite Keyway position
- P** Locked out of and into Keyway Side position

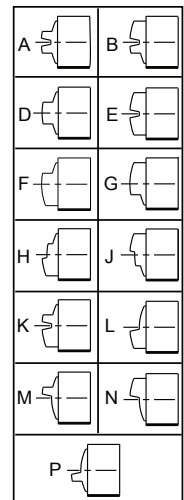

COMMERCIAL & MIL TOGGLE SWITCHES

T9
TOGGLES

PRODUCT FAMILY TABLE

Single Pole

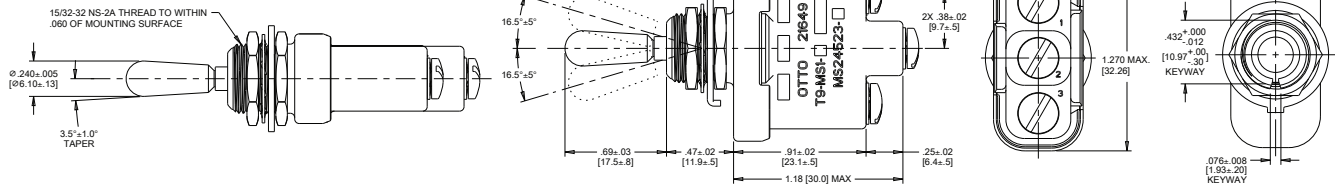

Low level 10mA @ 30mV

OTTO PART NO.	MILITARY NO.	CIRCUIT BY TOGGLE LEVER POSITION				ELECTRICAL RATINGS - SEA LEVEL & 65,000 FT					
		KEYWAY 1-2	CENTER	OPP. KEYWAY 2-3	SWITCH POSITION MARKING	28 VDC			115 VAC		
						LAMP	RESISTIVE	INDUCTIVE	LAMP	RESISTIVE	INDUCTIVE
T9-MS1-21	MS24523-21	ON	OFF	ON	ON OFF ON	5	20	15	3	15	10
T9-MS1-22	MS24523-22	OFF	NONE	ON	OFF ON						
T9-MS1-23	MS24523-23	ON	NONE	ON	ON ON						
T9-MS1-24	MS24523-24	NONE	OFF	ON	OFF ON						
T9-MS1-25	MS24523-25	NONE	MOM OFF	ON	OFF ON						
T9-MS1-26	MS24523-26	MOM ON	NONE	ON	ON ON						
T9-MS1-27	MS24523-27	MOM ON	OFF	MOM ON	ON OFF ON	4	15	10	2	15	7
T9-MS1-28	MS24523-28	MOM ON	OFF	NONE	ON OFF						
T9-MS1-29	MS24523-29	MOM OFF	NONE	ON	OFF ON						
T9-MS1-30	MS24523-30	MOM ON	NONE	OFF	ON OFF						
T9-MS1-31	MS24523-31	MOM ON	OFF	ON	ON OFF ON						
OTTO PART NO.	MILITARY NO.	KEYWAY	CENTER 1-2	OPP. KEYWAY 2-3	SWITCH POSITION MARKING						
T9-MS1-32	MS24523-32	NONE	ON	MOM ON	ON ON	4	15	10	2	15	7
T9-MS1-33	MS24523-33	NONE	ON	ON	ON ON	5	20	15	3	15	10

Lever/Lock Single Pole

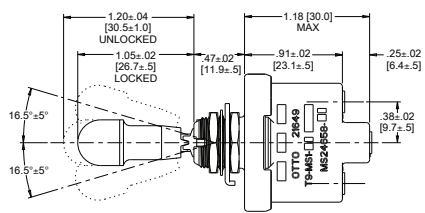
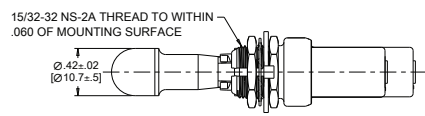
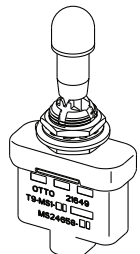
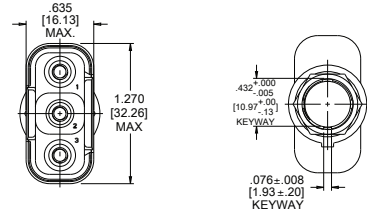
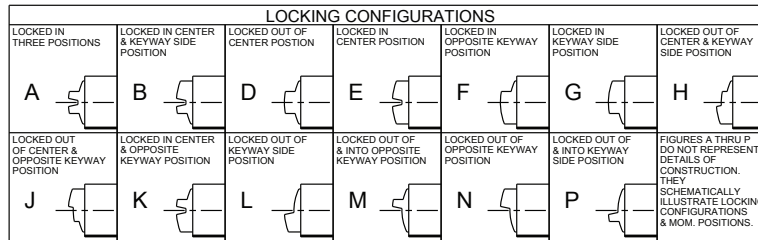

OTTO BASE PART NO.	MILITARY NO.	DASH NO.	AVAILABLE LOCKOUTS (SEE CHART)	CIRCUIT BY TOGGLE LEVER POSITION				ELECTRICAL RATINGS - SEA LEVEL & 65,000 FT					
				KEYWAY 1-2	CENTER	OPP. KEYWAY 2-3	SWITCH POSITION MARKING	28 VDC			115 VAC		
								LAMP	RESISTIVE	INDUCTIVE	LAMP	RESISTIVE	INDUCTIVE
T9-MS1-	MS24658-	21	ALL	ON	OFF	ON	ON OFF ON	5	20	15	3	15	10
		22	D F G	OFF	NONE	ON	OFF ON						
		23	D F G	ON	NONE	ON	ON ON						
		24	E F K M	NONE	OFF	ON	OFF ON						
		25	F	NONE	OFF (M)	ON	OFF ON						
		26	F	MOM ON	NONE	ON	ON ON						
		27	E L N	MOM ON	OFF	MOM ON	ON OFF ON	4	15	10	2	15	7
		28	E	MOM ON	OFF	NONE	ON OFF						
		29	F	MOM OFF	NONE	ON	OFF ON						
		30	F	MOM ON	NONE	OFF	ON OFF						
		31	E F K L M N	MOM ON	OFF	ON	ON OFF ON						
OTTO BASE NO.	MILITARY NO.	DASH NO.	AVAILABLE LOCKOUT	KEYWAY	CENTER 1-2	OPP. KEYWAY 2-3	SWITCH POSITION MARKING						
T9-MS1-	MS24658-	32	E	NONE	ON	MOM ON	ON ON	4	15	10	2	15	7
T9-MS1-	MS24658-	33	E F K M	NONE	ON	ON	ON ON	5	20	15	3	15	10

PRODUCT FAMILY TABLE

Double Pole

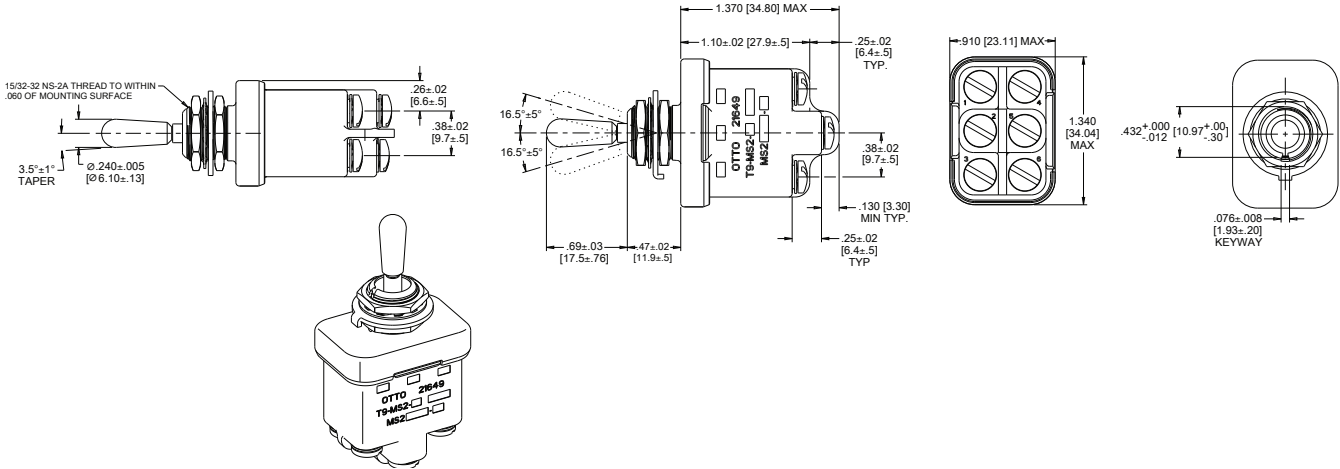

Low level 10mA @ 30mV

OTTO BASE PART NO.	MILITARY STANDARD	DASH NO.	CIRCUIT CONFIGURATION				SWITCH POSITION MARKING	ELECTRICAL RATINGS - SEA LEVEL & 65,000 FT					
			KEYWAY 1-2 / 4-5	CENTER	OPP. KEYWAY 2-3 / 5-6	LAMP		28 VDC			115 VAC, 60Hz & 400Hz		
								RESISTIVE	INDUCTIVE	LAMP	RESISTIVE	INDUCTIVE	
T9-MS2-	MS24524-	21	ON	OFF	ON	ON OFF ON	7	20	15	4	15	15	
		22	OFF	NONE	ON	OFF ON							
		23	ON	NONE	ON	ON ON							
		24	NONE	OFF	ON	OFF ON	5	18	10	2	11	8	
		25	NONE	MOM OFF	ON	OFF ON							
		26	MOM ON	NONE	ON	ON ON							
		27	MOM ON	OFF	MOM ON	ON OFF ON							
		28	MOM ON	OFF	NONE	ON OFF							
		29	MOM OFF	NONE	ON	OFF ON							
30	MOM ON	NONE	OFF	ON OFF									
31	MOM ON	OFF	ON	ON OFF ON									
OTTO BASE PART NO.	MILITARY STANDARD	DASH NO.	KEYWAY	CENTER 1-2 / 4-5	OPP. KEYWAY 2-3 / 5-6	SWITCH POSITION MARKING	28 VDC			115 VAC			
							LAMP	RESISTIVE	INDUCTIVE	LAMP	RESISTIVE	INDUCTIVE	
T9-MS2-	MS24524-	32	NONE	ON	MOM ON	ON ON	5	18	10	2	11	8	
		33	NONE	ON	ON	ON ON	7	20	15	4	15	15	
OTTO PART NO.	MILITARY STANDARD	DASH NO.	KEYWAY	CENTER	OPPOSITE KEYWAY	SWITCH POSITION MARKING	28 VDC			115 VAC, 60Hz & 400Hz			
							LAMP	RESISTIVE	INDUCTIVE	LAMP	RESISTIVE	INDUCTIVE	
T9-MS2-01	MS27407-	1	1-2 ON 4-5	2-3 ON 4-5	2-3 ON 5-6	ON ON ON	7	20	15	4	15	15	
T9-MS2-02		2	MOM. 1-2 ON 4-5	2-3 ON 4-5	2-3 ON 5-6	ON ON ON	5	18	10	2	11	8	
T9-MS2-03		3	MOM. 1-2 ON 4-5	2-3 ON 4-5	MOM. 2-3 ON 5-6	ON ON ON							
T9-MS2-04		4	1-2 ON 4-5	1-2 ON 5-6	2-3 ON 5-6	ON ON ON	7	20	15	4	15	15	
T9-MS2-05		5	MOM. 1-2 ON 4-5	1-2 ON 5-6	2-3 ON 5-6	ON ON ON	5	18	10	2	11	8	
T9-MS2-06		6	MOM. 1-2 ON 4-5	1-2 ON 5-6	MOM. 2-3 ON 5-6	ON ON ON							

PRODUCT FAMILY TABLE

Lever/Lock Double Pole

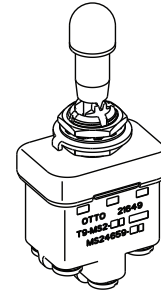
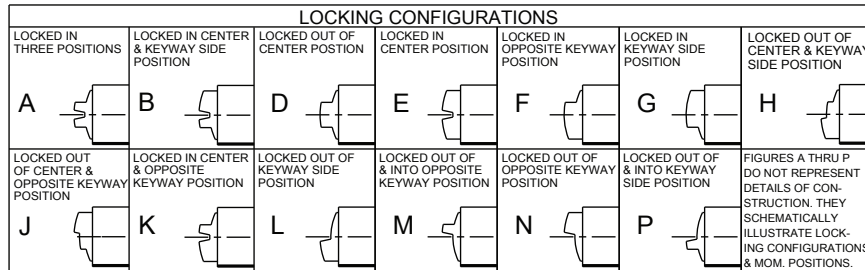
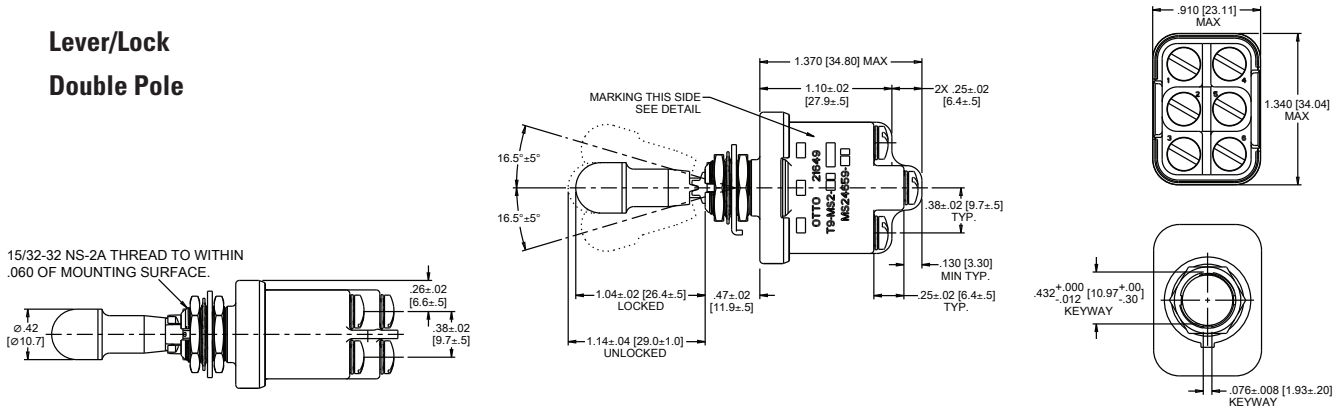

OTTO BASE PART NO.	MILITARY STANDARD	DASH NO.	AVAILABLE LOCKOUTS (SEE CHART)	CIRCUIT CONFIGURATION			SWITCH POSITION MARKING	ELECTRICAL RATINGS - SEA LEVEL & 65,000 FT					
				KEYWAY 1-2 / 4-5	CENTER 1-2 / 4-5	OPP. KEYWAY 2-3 / 5-6		28 VDC			115 VAC, 60Hz & 400Hz		
								LAMP	RESISTIVE	INDUCTIVE	LAMP	RESISTIVE	INDUCTIVE
T9-MS2-	MS24659-	21	ALL	ON	OFF	ON	ON OFF ON	7	20	15	4	15	15
		22	D,F,G	OFF	NONE	ON	OFF ON						
		23	D,F,G	ON	NONE	ON	ON ON						
		24	E,F,K,M	NONE	OFF	ON	OFF ON	5	18	10	2	11	8
		25	F	NONE	MOM OFF	ON	OFF ON						
		26	F	MOM ON	NONE	ON	ON ON						
		27	E,L,N	MOM ON	OFF	MOM ON	ON OFF ON						
		28	E	MOM ON	OFF	NONE	ON OFF						
		29	F	MOM OFF	NONE	ON	OFF ON						
30	F	MOM ON	NONE	OFF	ON OFF								
31	E,F,K,L,M,N	MOM ON	OFF	ON	ON OFF ON								
OTTO BASE PART NO.	MILITARY STANDARD	DASH NO.	AVAILABLE LOCKOUT	KEYWAY	CENTER 1-2 / 4-5	OPP. KEYWAY 2-3 / 5-6	SWITCH POSITION MARKING	28 VDC			115 VAC		
T9-MS2-	MS24659-	32	E	NONE	ON	MOM ON	ON ON	5	18	10	2	11	8
		33	E,F,K,M	NONE	ON	ON	ON ON	7	20	15	4	15	15