

HALL EFFECT LINEAR OUTPUT PUSHBUTTONS

HPL
LINEAR OUTPUT
PUSHBUTTONS

1 MILLION LINEAR OUTPUT CYCLES USING CONTACTLESS HALL EFFECT TECHNOLOGY

The HPL Hall Effect Linear Output Pushbutton Switch utilizes Hall effect technology to provide the user an output proportional to the travel of the button. The HPL delivers up to 1 million cycles. This rugged switch is ideal for applications where a simple on/off control is insufficient and a linear output is desired. Using the HPL, an operator can control the motion of a device as well as the speed of the movement. The HPL switch is an ideal control device for valves and variable speed drives, and can be used in industrial control, heavy equipment and material handling applications.

The HPL is offered as a stand-alone switch and in a dual HPL rocker assembly. As with all OTTO switches, a wide variety of case and button styles and colors are offered, along with various termination styles and two levels of sealing. OTTO can provide custom configurations as well as provide the HPL switches installed in a control grip.

Features:

- Programmable outputs of 0.5 to 4.5 volts
- 1 million cycles
- Hall effect for reliable contactless switching
- Watertight per IP68S available
- Front or behind panel mounting
- Wire or pinned termination options
- Rocker version available
- RoHS compliant



HPL-4
15/32" – 32 Thread
Rear Mount



HPL-R
Hall Effect Rocker



HPL-3
5/8" Front Mount

HPL PART NUMBER CODE

Case Style	Output	Terminal Style	Seal Level	Case Color	Button Color	Button Style*
1. Press Fit	1. 1.0 - 4.0VDC	1. 3 Straight Pins, 0.100" Centers	1. IP65 Splashproof	1. Clear Anodized	1. Red	1. 0.375" OD (Case Styles 1, 3, 4 & 6)
3. Front Mount 5/8" Thread	2. 4.0 - 1.0VDC	2. 18" Potted 22 AWG Wire Leads	2. IP68S Watertight	2. Black Anodized	2. Black	2. 0.500" OD Domed (Case Styles 1, 3 & 6)
4. Rear Mount 15/32" Thread	3. 0.5 - 4.5VDC				3. Orange	
6. Rear Mount 5/8" Thread	4. 4.5 - 0.5VDC				4. Yellow	
R. Rocker Assembly					5. Green	R. Rocker Assembly (Case Style R)
					6. Blue	
					7. Purple	
					8. Gray	
					9. White	

Votre distributeur officiel

ALDERS electronic GmbH
Arnoldstraße 19
47906 Kempen - Allemagne

+33 3 88064677
+33 6 33389393
catherine.sturm@alders.fr / www.alders.fr

Indicate. Control. Connect.

* For availability of larger button diameters, contact factory.

1 MILLION LINEAR OUTPUT CYCLES USING CONTACTLESS HALL EFFECT TECHNOLOGY

Standard Characteristics/Ratings:

MECHANICAL:

Mechanical Life:	1,000,000 cycles full stroke per button
Button Travel:	0.135 inches min to 0.160 inches max
Full Travel Force:	0.15 inches, 3.0 lbs. typical to 3.8 lbs. max @ 25°C
Reset Force:	5 oz min @ 25°C
Electrical Life:	1,000,000 cycles

ELECTRICAL RATINGS: Rated at Vcc = 5V @ 25°C Load = 1mA (4.7KΩ)

Electrical	Units	1 - 4 Volts			4 - 1 Volts			0.5 - 4.5 Volts			4.5 - 0.5 Volts		
		Min	Typ	Max	Min	Typ	Max	Min	Typ	Max	Min	Typ	Max
Supply Voltage	VDC	4.5	5	5.5	4.5	5	5.5	4.5	5	5.5	4.5	5	5.5
Output Voltage (Button Up)	VDC @ 5V Vcc	0.85	1	1.15	3.85	4	4.15	0.35	0.5	0.65	4.35	4.5	4.85
Output Voltage (Button Down)	VDC @ 5V Vcc	3.85	4	4.15	0.85	1	1.15	4.35	4.5	4.65	0.35	0.5	0.65
Supply Current	mA	N/A	8	10	N/A	8	10	N/A	8	10	N/A	8	10
Continuous Output Current	mA	-1	N/A	1	-1	N/A	1	-1	N/A	1	-1	N/A	1
Output Resistance (Io ≤ -2mA)	Ω	N/A	1	10	N/A	1	10	N/A	1	10	N/A	1	10

ELECTRONICS:

Seal Integrity: IP65 or IP68S

ENVIRONMENTAL:

Operating Temp Range: -40°C to +85°C

Humidity: 96% RH, 70°C, 96 hours

MATERIALS:

Housing: Anodized Aluminum alloy

Button Cap: Thermoplastic

Mounting Hardware: Lockwasher, hex nut, washer when applicable

.375" O.D. Button Style

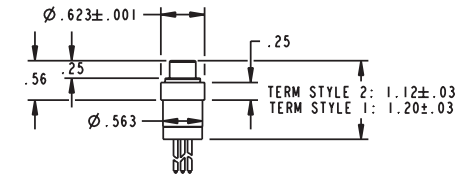

HPL - 1XXXXX I
PRESS FIT

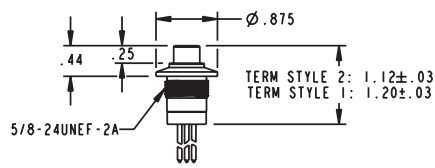

HPL - 3XXXXX I
5/8" THREAD
FRONT MOUNT

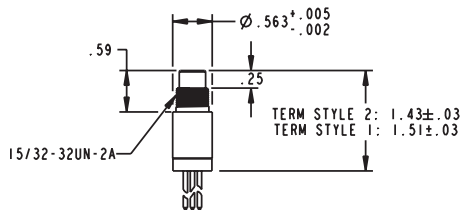

HPL - 4XXXXX I
15/32" THREAD
REAR MOUNT

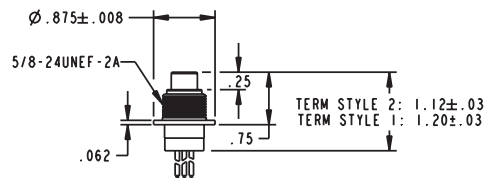

HPL - 6XXXXX I
5/8" THREAD
REAR MOUNT

HALL EFFECT LINEAR OUTPUT PUSHBUTTONS

HPL
LINEAR OUTPUT
PUSHBUTTONS

1 MILLION LINEAR OUTPUT CYCLES USING CONTACTLESS HALL EFFECT TECHNOLOGY

Case Styles

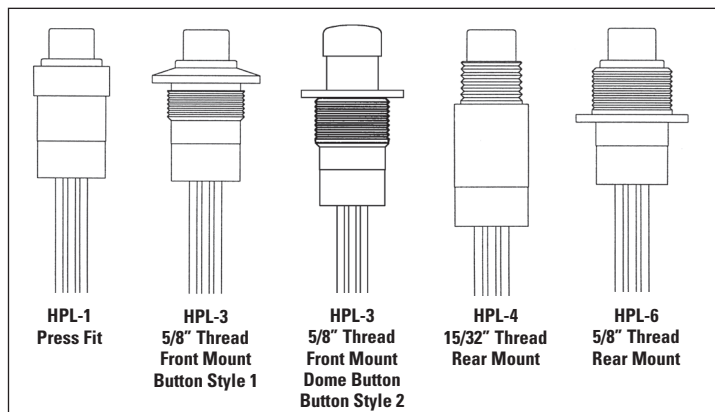

HPL dimensions are equivalent to standard OTTO P1 Pushbutton dimensions as shown in the catalog except for overall length. Total button height is 0.25" on standard 0.375" OD buttons. Overall length from button top to rear of potting is 1.26" nominal, except for the HPL-4 and 0.500" OD button styles which measure 1.56". Panel mounting hardware is included, except with the HPL-1 which is meant to press fit into mounting hole in a control grip. Refer to the dimensions shown or consult OTTO to design the control grip to meet your specifications.

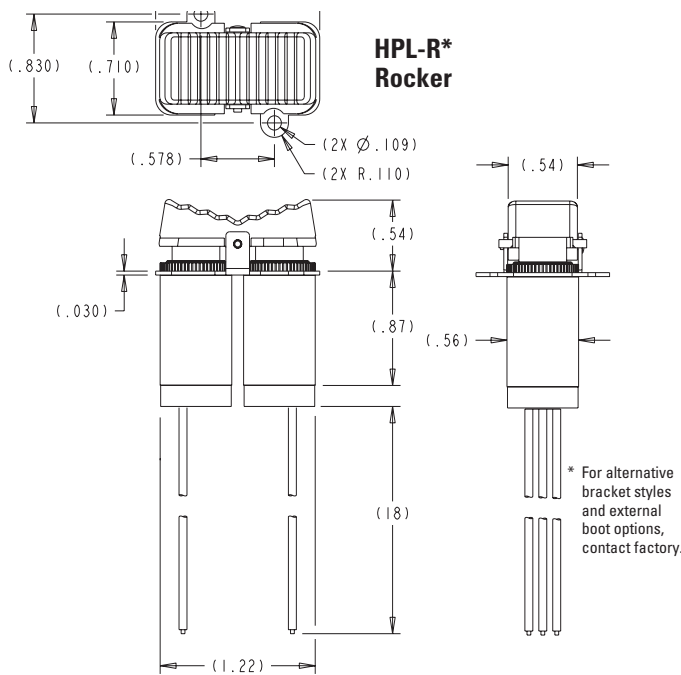

Terminal Styles

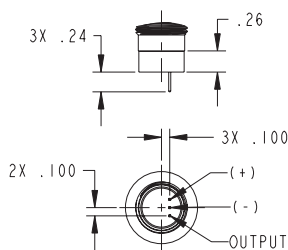

TERMINAL STYLE 1
3 STRAIGHT PINS
.100 CENTERS

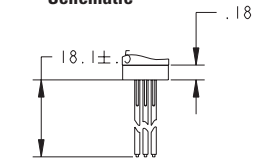
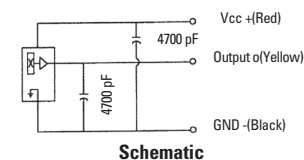

TERMINAL STYLE 2
18" POTTED
22 AWG, UL 1569
WIRE LEADS

Linear Output Graphs (Vcc = 5V @ 20°C)

