

SEALED, ILLUMINATED ROCKER SWITCHES

K1/K2
SNAP-IN
ROCKERS

LOW COST, SNAP-IN ROCKER FOR WET & DUSTY ENVIRONMENTS

The K series rockers are rugged, high performance sealed switches designed for use under severe conditions found in marine, appliance, heavy equipment and industrial control applications.

The K1 and K2 series are sealed to IP68S and IP69K and panel sealed with an optional panel gasket.

The K1 series is offered in single pole configuration and the K2 series is available in both single and double pole configurations. Both series offer illuminated models. Illumination can be independent or dependent of the switch position or a combination of both. A choice of red, green, clear or amber colored lenses are offered in illuminated models. Illumination options include incandescent, LED or neon light sources.

Mounting is simple and quick; snaps into panel from the front. The OTTO snap-in design supports a variety of panel thicknesses with just one cutout size.

A choice of models are offered to handle high power levels and logic level electronic switching applications.

Custom colors are available upon request. Value-added assemblies with wire leads are also available. Please contact our factory for assistance.



K1 Series
Single Pole



K2 Series
Single & Double Pole



Features:

- Sealed to IP68S and IP69K
- Fits industry standard panel openings for drop-in replacement of panel sealed & unsealed switches
- Snap-in feature accommodates a wide range of panel cutouts
- UV & solvent resistant
- Withstands extreme shock & vibration
- Custom legends available
- 2 & 3-position, momentary & maintained action
- Incandescent, LED & neon illumination with independent & dependent light source options
- UL recognized
- Ignition protected
- Optional one-piece connector
- Optional panel gasket available
- RoHS compliant

Standard Characteristics/Ratings:

ELECTRICAL RATINGS:

Load	Sea Level @ 28VDC	Sea Level @ 125/250 VAC, 60/400Hz	Cycles
Resistive	16A	5A	25,000
Resistive	10A	N/A	50,000
Inductive	7A	2A	25,000
DWV	1000Vrms except across light terminals		
Logic Level	10mA @ 5VDC, max D.C. logic level ratings (void if logic level load(s) exceeded at any time)		

Electrical Life: See Rating Chart

LIGHTING:

Light Source Rating (see appendix for complete voltage/current ratings table)

Incandescent	(VDC) 6V, 12V, 24V
Neon	(VAC) 125V, 250V
LED	(VDC) 2V, 6V, 12V, 24V

Mechanical Life: 100,000 cycles

Seal: IP68S and IP69K

Operating Temp Range: -30°C to +85°C

MATERIALS:

Case:	Thermoplastic
Button:	Thermoplastic
Base:	Thermoplastic
Terminals/Contact:	Brass, silver alloy with silver plate, gold flash for logic level
Terminal Hardware:	Screws and lockwashers provided when applicable K1/K2 series recommended Quick Connect terminals: AMP 60253-2 for 12-16 AWG AMP 42100-2 for 14-18 AWG
Mounting Hardware:	None provided

Ihr offizieller Vertriebspartner



ALDERS
Indicate. Control. Connect.

ALDERS electronic GmbH
Arnoldstraße 19
47906 Kempen
+49 2152 8955-0
vertrieb@alders.de / www.alders.de

SEALED, ILLUMINATED ROCKER SWITCHES

LOW COST, SNAP-IN ROCKER FOR WET & DUSTY ENVIRONMENTS

K1 PART NUMBER CODE

Part Number Code Continued Below

K1

X

X

X

X

Terminal Style/ Switch Rating

- A. Q.C./Std.
- B. Screw/Std.
- C. Solder/Std.
- D. Q.C./Logic Level
- E. Screw/Logic Level
- F. Solder/Logic Level
- G. PC Pin/Std.
- H. PC Pin/Logic Level

Actuator Color/Style

- A. Red/Rocker
- B. Black/Rocker
- C. White/Rocker
- D. Red/Paddle
- E. Black/Paddle
- F. White/Paddle
- G. Red/Rocker Pinned
- H. Black/Rocker Pinned
- J. White/Rocker Pinned
- K. Red/Short Paddle Pinned
- L. Black/Short Paddle Pinned
- M. White/Short Paddle Pinned
- N. Red/Standard Paddle Pinned
- P. Black/Standard Paddle Pinned
- R. White/Standard Paddle Pinned
- T. Red/Short Paddle
- U. Black/Short Paddle
- V. White/Short Paddle

Switch Action/Circuit

	Position "A"	Position "B"	Position "C"	Circuit
A.	1-C	NONE	OFF	SPST
B.	1-C	NONE	2-C	SPDT
C.	(1-C)	NONE	OFF	SPST
D.	(1-C)	NONE	2-C	SPDT
E.	(1-C)	OFF	(2-C)	SPDT
F.	1-C	OFF	2-C	SPDT
G.	(1-C)	OFF	2-C	SPDT
H.	OFF	NONE	2-C	SPST

NOTE: () denotes momentary action.

Light Type*

- A. No Light
- B. 6V Incandescent
- C. 12V Incandescent
- D. 24V Incandescent
- E. 125VAC Neon
- F. 250VAC Neon
- G. 2V Red LED
- H. 2V Green LED
- J. 2V Amber LED
- K. 6V Red LED
- L. 6V Green LED
- M. 6V Amber LED
- N. 12V Red LED
- P. 12V Green LED
- Q. 12V Amber LED
- R. 24V Red LED
- S. 24V Green LED
- T. 24V Amber LED

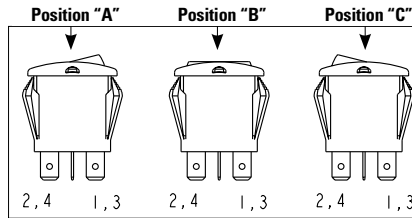

*See appendix for complete voltage/ratings table

K1 PART NUMBER CODE CONTINUED FROM ABOVE

K1 Continued

X

X

X

X

Lens Color

- | Position "A" | Position "C" |
|--------------|--------------|
| A. No Lens | A. No Lens |
| B. Red | B. Red |
| C. Green | C. Green |
| D. Amber | D. Amber |
| E. Clear | E. Clear |

Light/Circuit Location

A. No Light

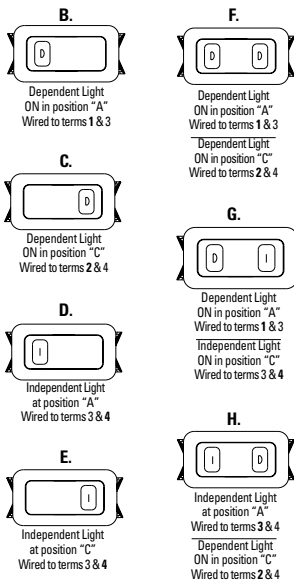

Legend & Orientation

A. None

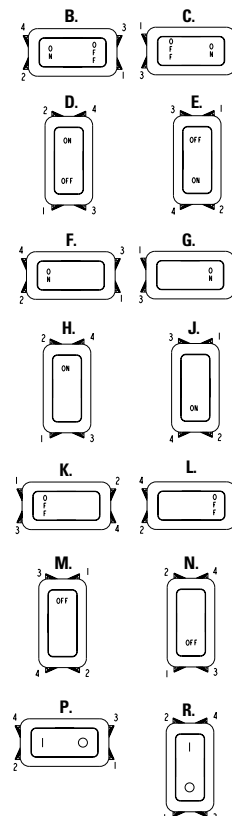

NOTES:

- No momentary switches with dependent lights.
- Neon lamps only to be coded with clear or amber lenses.
- LED lenses must be clear or same color as LED.
- No dependent light in OFF position.
- All legends printed on actuators without lens(es) will be white except actuator codes C, F, J, M & R.
- All legends printed on lenses will be white except on clear lens(es) will be black.

D = Dependent Light
I = Independent Light

NOTES:

- LED anode (+) terminal number shown in bold.
- Light on OFF side must be independent.
- Contact factory for multiple light types in the same switch.

• K1 panel plugs available as shown in Panel Plugs (PP) section.

Specifications Subject To Change Without Notice

SEALED, ILLUMINATED ROCKER SWITCHES

K1
SNAP-IN
ROCKERS

LOW COST, SNAP-IN ROCKER FOR WET & DUSTY ENVIRONMENTS

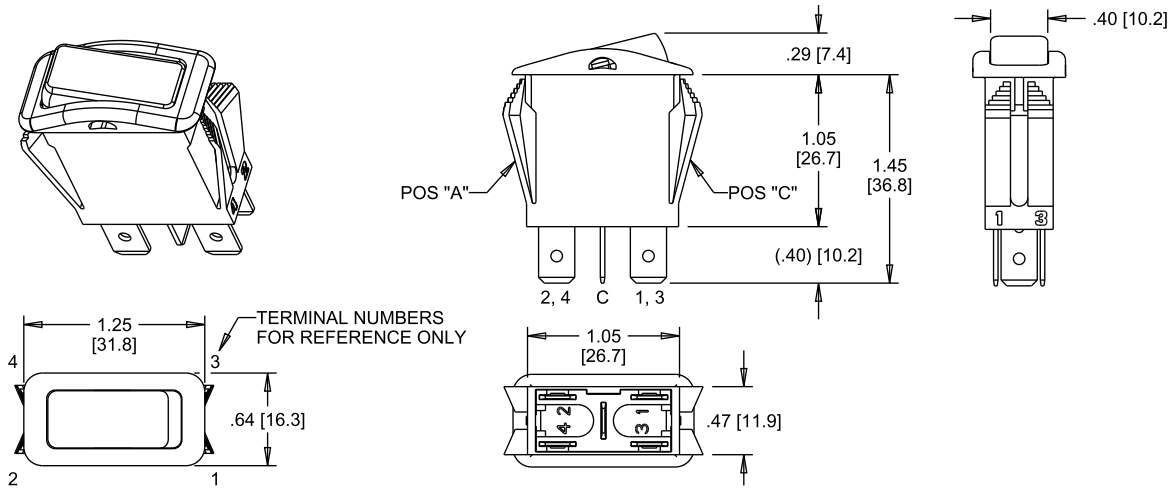

PANEL THICKNESS AND MOUNTING OPENING GUIDELINES:

PANEL THICKNESS RANGE OF .025 - .105
(GASKET RECOMMENDED)

PANEL THICKNESS RANGE OF .105 - .187
(GASKET NOT REQUIRED)

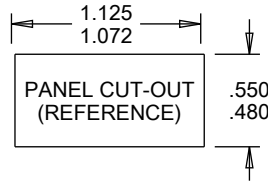

OPTIONAL PANEL GASKET:

0.062" THICKNESS = P/N C807039-25-1

0.031" THICKNESS = P/N C807039-25-2

P.C. PIN LAYOUT	PADDLE STYLES		
	SHORT PADDLE ROCKER	STANDARD PADDLE ROCKER	STANDARD ROCKER
	TERMINAL STYLES (.032 [.81] THICK)		
	SCREW	QUICK CONNECT	SOLDER
	P.C. PIN		

K1 AND T71 CONNECTOR PART NUMBER CODE

C405041 -

XX

XXXX

Connector Color

- 01. Red
- 02. Black
- 03. Orange*
- 04. Yellow*
- 05. Green*
- 06. Blue*
- 07. Violet*
- 08. Gray*
- 09. White

* Contact Factory

Packaging Quantity

- 0025 - 25 Pcs per Package
- 0050 - 50 Pcs per Package
- 0100 - 100 Pcs per Package

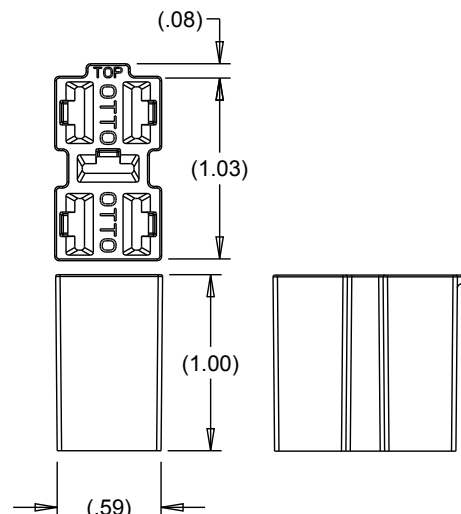

SEALED, ILLUMINATED ROCKER SWITCHES

LOW COST, SNAP-IN ROCKER FOR WET & DUSTY ENVIRONMENTS

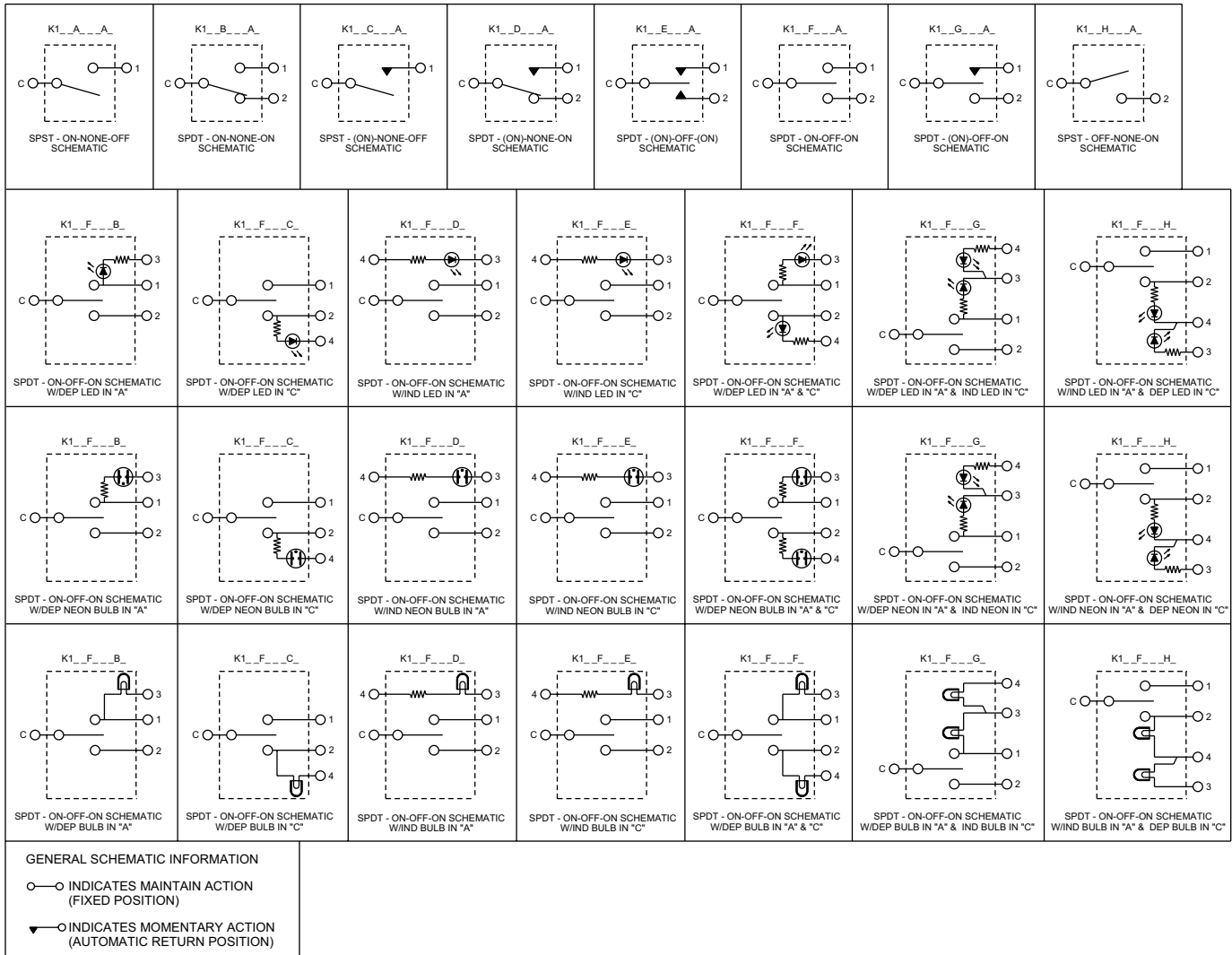

K1, K2, K3P and K4 LIGHTING VOLTAGE/CURRENT COMPONENTS RATINGS

LIGHT SOURCE VOLTAGE CATEGORY	LIGHT SOURCE COLOR	FORWARD CURRENT	TYPICAL FORWARD/NOMINAL VOLTAGE (DC)	MAX. FORWARD VOLTAGE (DC)
6VDC INCANDESCENT	WHITE	.2A	6V	8V
12VDC INCANDESCENT	WHITE	.08A	12V	14V
24VDC INCANDESCENT	WHITE	.04A	24V	28V
125VAC NEON	AMBER	1.9mA	125V	125V
250VAC NEON	AMBER	1.9mA	250V	250V
2V LED*	RED	20mA	1.9V	2.5V
	GREEN	20mA	2.15V	2.5V
	AMBER	20mA	1.95V	2.5V
	BLUE	20mA	3.5V	4.0V
6VDC LED	SEE CHART	20mA	6V	8V
12VDC LED	SEE CHART	20mA	12V	14V
24VDC LED	SEE CHART	20mA	24V	28V

* See Appendix for complete Voltage/Ratings Table.