

# General Specifications

## Electrical Capacity (Resistive Load)

**Low Level:** 100mA maximum @ 12V DC

## Other Ratings

<b>Contact Resistance:</b>	200 milliohms maximum
<b>Insulation Resistance:</b>	100 megohms minimum @ 250V DC
<b>Dielectric Strength:</b>	1,000V AC minimum between contacts for 1 minute minimum 1,500V AC minimum between contacts & case for 1 minute minimum
<b>Mechanical Life:</b>	5,000,000 operations minimum; 1,000,000 operations minimum for custom Rectangular Switch/Cap Assembly (at center of cap)
<b>Electrical Life:</b>	5,000,000 operations minimum
<b>Nominal Operating Force:</b>	<b>KP01:</b> 1.9N maximum for Tactile & Nontactile models (at center of cap) <b>KP02:</b> 1.6N maximum for Tactile, Nontactile & Tactile/Audible models (at center of cap)
<b>Travel:</b>	<b>KP01:</b> Pretravel .122" (3.1mm); Overtravel .055" (1.4mm); Total Travel .177" (4.5mm) <b>KP02:</b> Pretravel .091" (2.3mm); Overtravel .047" (1.2mm); Total Travel .138" (3.5mm)

## Materials & Finishes

<b>Plunger/Upper Housing:</b>	Polyacetal
<b>Lower Housing:</b>	Glass fiber reinforced PBT (UL94V-0)
<b>Movable Contact:</b>	Stainless steel with gold plating
<b>Stationary Contacts:</b>	Gold over copper alloy
<b>Switch Terminals:</b>	Brass with tin plating

## Environmental Data

<b>Operating Temperature Range:</b>	-25°C through +50°C (-13°F through +122°F)
<b>Humidity:</b>	90-95% humidity for 240 hours @ 40°C (104°F)
<b>Vibration:</b>	10 ~ 55Hz with peak-to-peak amplitude of 1.5mm traversing the frequency range & returning in 1 minute; 3 right angled directions for 2 hours
<b>Shock:</b>	51G (500m/s <sup>2</sup> ) acceleration (tested in 6 right angled directions, with 5 shocks in each direction)

## Installation

**Cap Installation Force :** 50.0N maximum downward force on actuator

## PCB Processing

<b>Soldering:</b>	Wave Soldering. Preheat Temperature: 140°C @ 60 seconds; Peak Temperature: 270°C @ 11 seconds; Thickness of PCB: 1.6mm; Cycles: 2 Manual Soldering. 410°C @ 4 seconds for 2 cycles
<b>Cleaning:</b>	These devices are not process sealed. Hand clean locally using alcohol based solution.

## Standards & Certifications

**Flammability Standards:** UL94V-0 lower housing

The KP Series pushbuttons have not been tested for UL recognition or CSA certification. These switches are designed for use in a low-voltage, low-current, logic-level circuit. When used as intended in a logic-level circuit, the results do not produce hazardous energy.

# Distinctive Characteristics

KP series offers a complete switch solution for all broadcast panel needs, including home keys and the rectangular switch/cap assembly.

Distinct, long total travel of .177" (4.5mm) for KP01 or shorter stroke of .138" (3.5mm) for KP02.

Available with super bright red/green or amber/blue bicolor LED or RGB LED. The super bright RGB LED provides vibrant full color spectrum in unlimited color combinations.

Unique actuation guide gives positive indication of circuit transfer as well as smooth and silent operation.

Choices of tactile, nontactile or tactile/audible actuation.

Compact design with height of .906" (23.0mm) from PC board to top of cap. (Same height as programmable SmartSwitch™.)

Flat, sculptured or home key square caps in three common sizes for design flexibility in audio/video applications.

Twin contacts with gold plating assure high reliability and long life of 5,000,000 operations minimum.

Improved profile for soldering specifications. Custom legends are davailable.



Actual Size

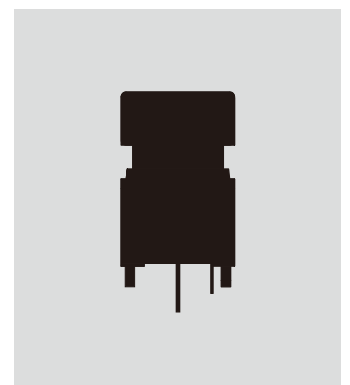

### TYPICAL SWITCH

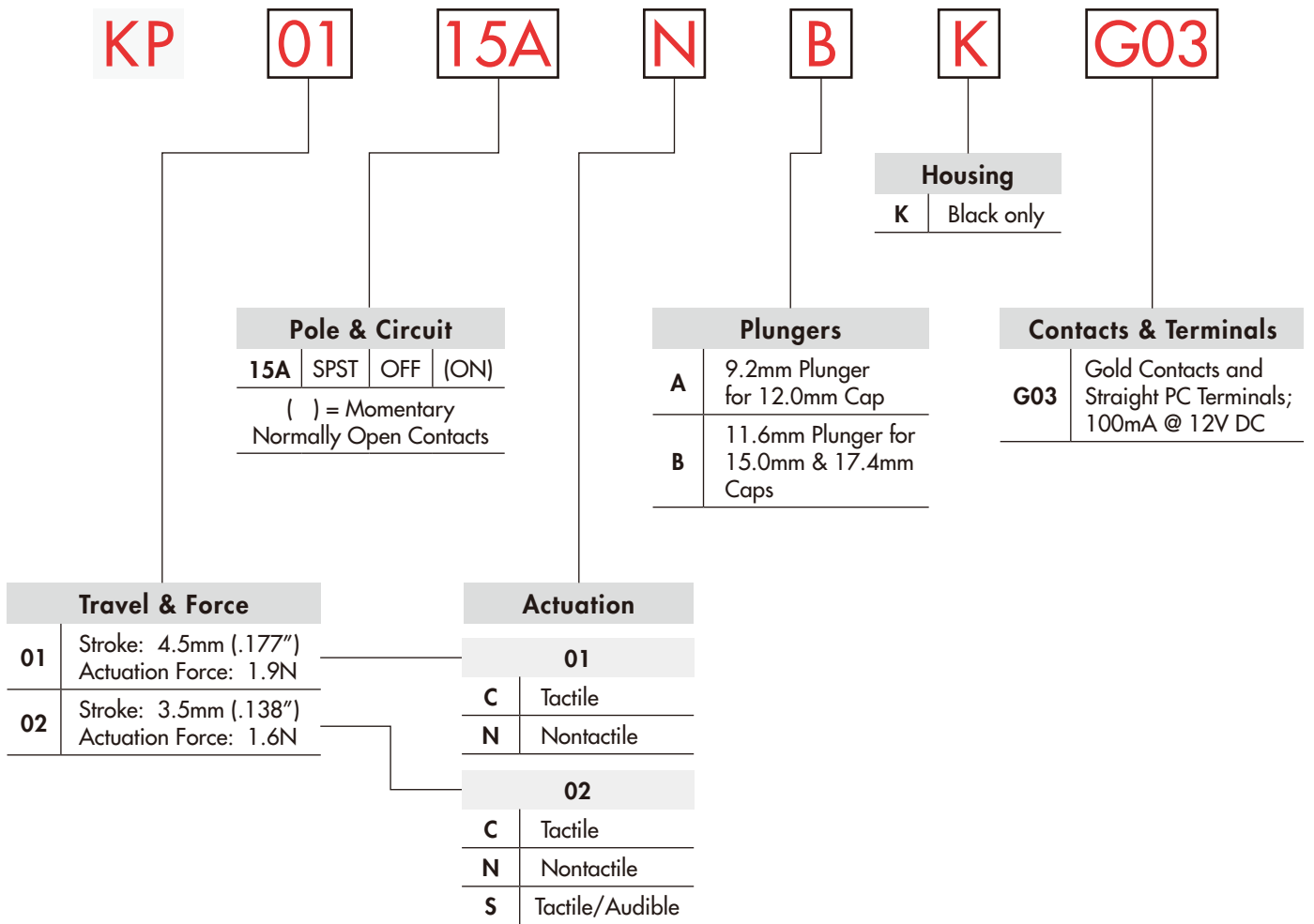

### DESCRIPTION FOR TYPICAL ORDERING EXAMPLE

**KP0115ANBK G036CF-2SJB**



ORDERING EXAMPLE

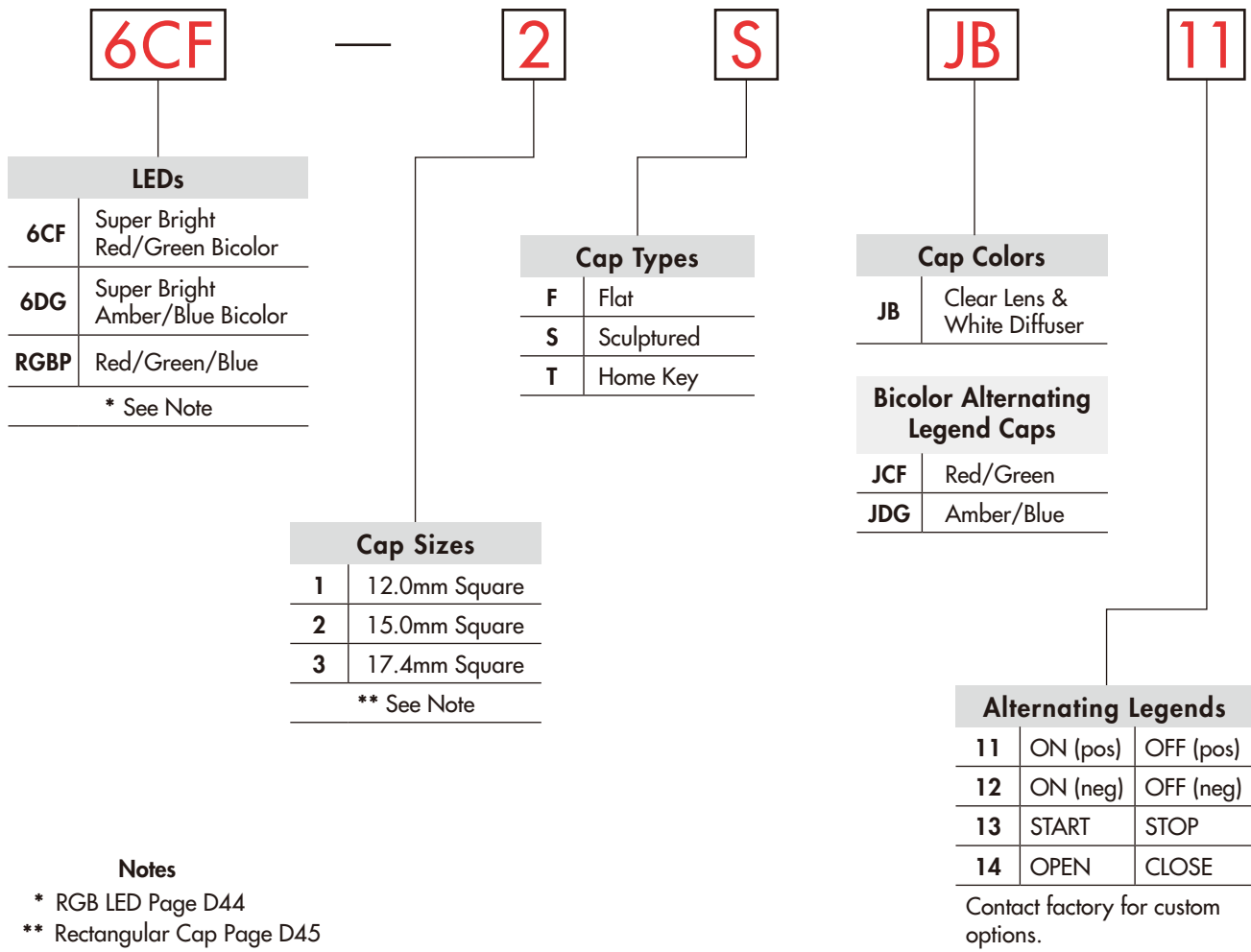

Notes

- \* RGB LED Page D44
- \*\* Rectangular Cap Page D45

Part Numbers for Alternating Legends				
Color	Cap Size	Flat Cap	Sculptured Cap	Home Key Cap
		Part Number	Part Number	Part Number
Red/Green	12mm Square	AT3093JCF11 ~ AT3093JCF14	AT3090JCF11 ~ AT3090JCF14	AT3096JCF11 ~ AT3096JCF14
	15mm Square	AT3094JCF11 ~ AT3094JCF14	AT3091JCF11 ~ AT3091JCF14	AT3097JCF11 ~ AT3097JCF14
	17.4mm Square	AT3095JCF11 ~ AT3095JCF14	AT3092JCF11 ~ AT3092JCF14	AT3098JCF11 ~ AT3098JCF14
Amber/Blue	12mm Square	AT3093JDG11 ~ AT3093JDG14	AT3090JDG11 ~ AT3090JDG14	AT3096JDG11 ~ AT3096JDG14
	15mm Square	AT3094JDG11 ~ AT3094JDG14	AT3091JDG11 ~ AT3091JDG14	AT3097JDG11 ~ AT3097JDG14
	17.4mm Square	AT3095JDG11 ~ AT3095JDG14	AT3092JDG11 ~ AT3092JDG14	AT3098JDG11 ~ AT3098JDG14

Refer to Ordering Table for Alternating Legend that corresponds with last 2 digits of part number.

Toggles  
 Rockers  
 Pushbuttons  
 Illuminated PB  
 Programmable  
 Keylocks  
 Rotaries  
 Slides  
 Tactiles  
 Tilt  
 Touch  
 Indicators  
 Accessories  
 Supplement

### POLE & CIRCUIT

Pole	Model	Plunger Position ( ) = Momentary		Connected Terminals		Throw & Switch Schematic
		Normal	Down	Normal	Down	
SP	KP0115A KP0215A	OFF	(ON)	Normally Open	1-1a	SPST 

Note: Switch terminals "1" & "1a" are actually marked on the switch.

### ACTUATION

### HOUSING

<b>C</b> Tactile KP01 or KP02	<b>N</b> Nontactile KP01 or KP02	<b>S</b> Tactile/Audible KP02 only	<b>K</b> Black only
----------------------------------	-------------------------------------	---------------------------------------	---------------------

### CONTACTS, TERMINALS, & RATING

<b>G03</b> Gold Contacts	Straight PC Terminals	100mA @ 12V DC
--------------------------	-----------------------	----------------

### SUPER BRIGHT BICOLOR LED SPECIFICATIONS

The electrical specifications shown are determined at a basic temperature of 25°C.

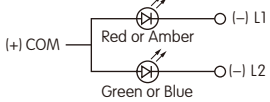
		Colors		<b>6CF</b>		<b>6DG</b>		Unit
		Red	Green	Amber	Blue			
LEDs are an integral part of the switch and are not available separately.	Minimum Luminous Intensity	$I_V$	230	220	204	113	mcd	
	Standard Luminous Intensity	$I_V$	290	270	340	188	mcd	
LED circuit is isolated and requires an external power source.	Maximum Forward Current	$I_{FM}$	30 25 for Amber	25 22 for Amber	30	25	mA	
	Typical Forward Current	$I_F$	15	5	20	20	mA	
If the source voltage exceeds the rated voltage, a ballast resistor is required.	Forward Voltage	$V_F$	2.0	3.1	2.1	3.2	V	
	Power Peak Dissipation	$P_D$	72	88	75	100	mW	
The resistor value can be calculated by using the formula in the Supplement section.	Maximum Reverse Voltage	$V_{RM}$	5	7	4	4	V	
	Wavelength at Peak Emission	$\lambda$	620 ~ 630	528 ~ 538	583 ~ 595	464 ~ 476	nm	
	Current Reduction Rate Above 25°C	$\Delta I_F$	0.40	0.36	0.40	0.33	mA/°C	
Ambient Temperature Range			-25 ~ +50		-25 ~ +50		°C	

Amber can be achieved by simultaneous illumination of Red & Green.  
 Purple can be achieved by simultaneous illumination of Amber & Blue.

## PLUNGERS

### A 9.2mm Plunger for 12.0mm Cap

9.2mm Plunger is designed with a narrower neck to hold the 12.0mm Cap.

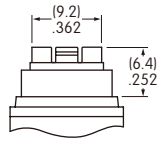

### B 11.6mm Plunger for 15.0mm & 17.4mm Caps

11.6mm Plunger is designed with a wider neck to hold both the 15.0mm and 17.4mm Caps.

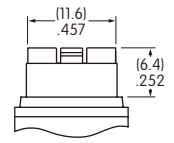

## CAP TYPES & COLORS

Caps for Bicolor and RGB

### 1 12.0mm Square Used on A Plunger

#### F AT3083 Flat Cap

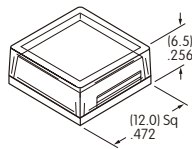

#### S AT3078 Sculptured Cap

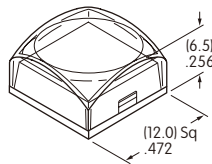

#### T AT3086 Home Key Cap

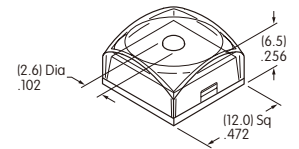

### 2 15.0mm Square Used on B Plunger

#### F AT3084 Flat Cap

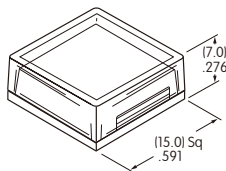

#### S AT3079 Sculptured Cap

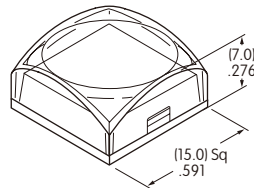

#### T AT3087 Home Key Cap

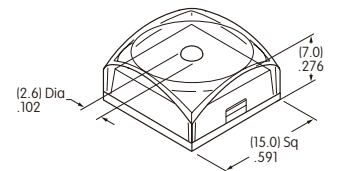

### 3 17.4mm Square Used on B Plunger

#### F AT3085 Flat Cap

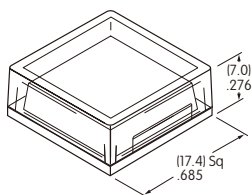

#### S AT3080 Sculptured Cap

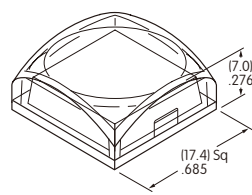

#### T AT3088 Home Key Cap

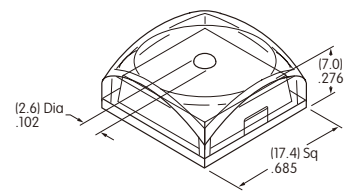

Toggles  
 Rockers  
 Pushbuttons  
 Illuminated PB  
 Programmable  
 Keylocks  
 Rotaries  
 Slides  
 Tactiles  
 Tilt  
 Touch  
 Indicators  
 Accessories  
 Supplement

### Caps for Alternating Legends

**1** **12.0mm Square** Used on A Plunger

**F** AT3093 Flat Cap

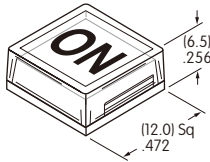

**S** AT3090 Sculptured Cap

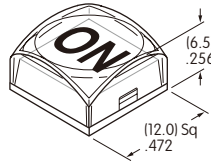

**T** AT3096 Home Key Cap

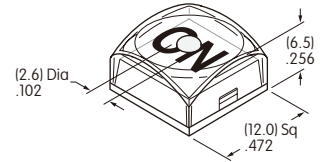

**2** **15.0mm Square** Used on B Plunger

**F** AT3094 Flat Cap

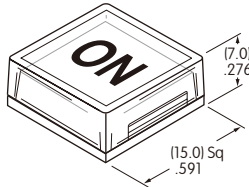

**S** AT3091 Sculptured Cap

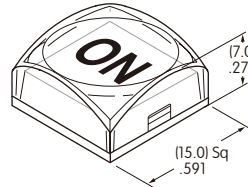

**T** AT3097 Home Key Cap

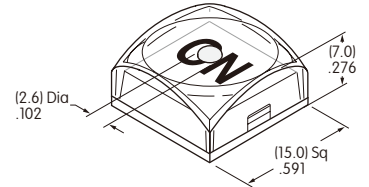

**3** **17.4mm Square** Used on B Plunger

**F** AT3095 Flat Cap

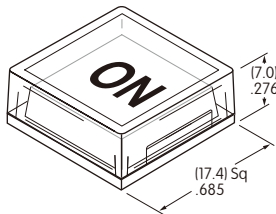

**S** AT3092 Sculptured Cap

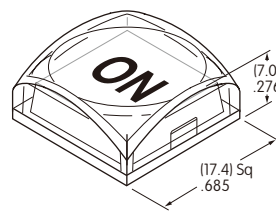

**T** AT3098 Home Key Cap

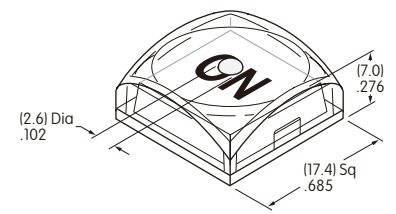

**JB** **Lens & Diffuser Colors Available:**

Clear/White

Materials & Finishes: Lens - Polycarbonate with glossy finish  
 Diffuser - Polycarbonate with textured finish  
 Optional Protective Guard AT4170 available; contact factory.

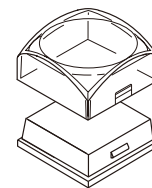

Clear Lens

White Diffuser

### Standard Alternating Legend Pairs



Green/Red or Blue/Amber



Green/Red or Blue/Amber



Green/Red or Blue/Amber



Green/Red or Blue/Amber

Cap illumination is alternating Green/Red or Blue/Amber; legend text is black.  
 Contact factory for other Alternating Legends.

Legend illustrations are approximate representations of the actual characters on the filters.

## TYPICAL SWITCH DIMENSIONS

### 12.0mm Square Cap

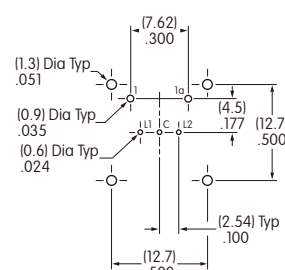
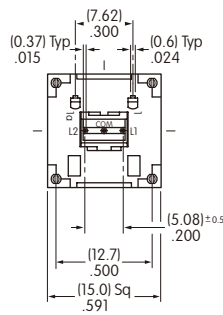
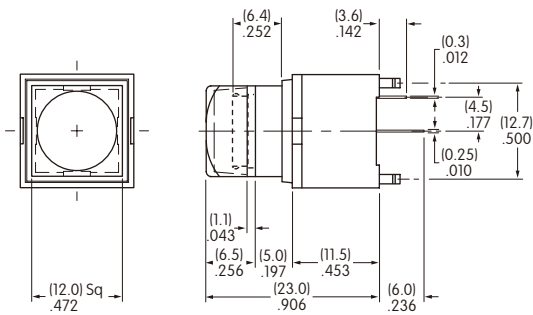

**KP01-15ACAKG036CF-1SJB**

### 15.0mm Square Cap

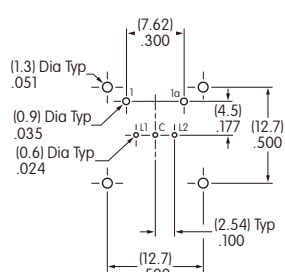
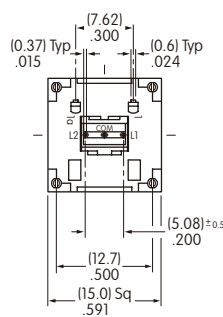
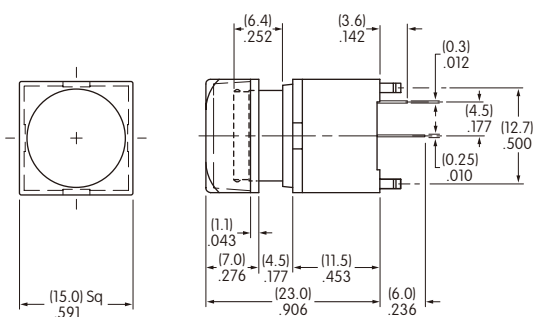

**KP01-15ANBKG036CF-2SJB**

### 17.4mm Square Cap

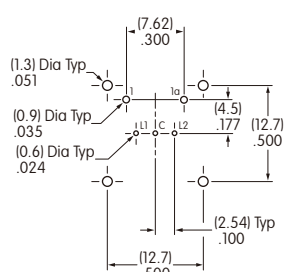
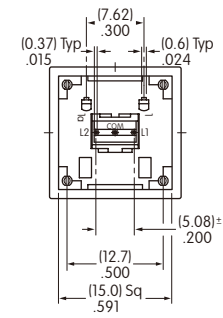
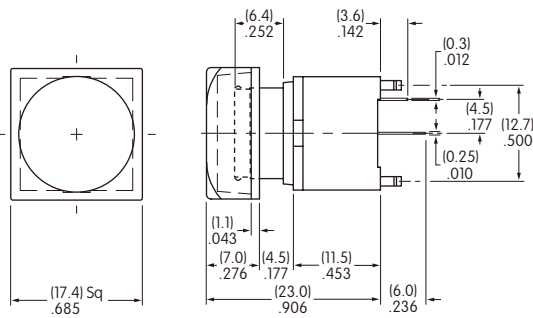

**KP01-15ANBKG036CF-3SJB**

### Bicolor Alternating Legend • 15.0mm Square Cap

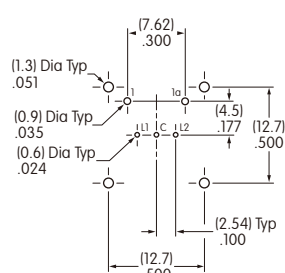
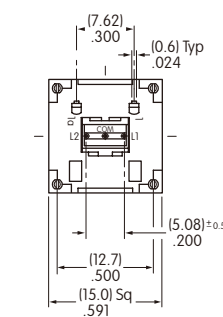
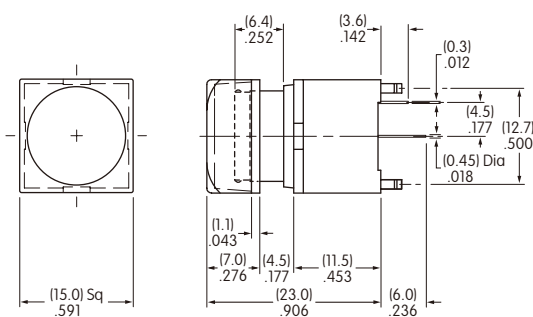

**KP01-15ANBKG036DG-2SJDG**



Toggles  
 Rockers  
 Pushbuttons  
 Illuminated PB  
 Programmable  
 Keylocks  
 Rotaries  
 Slides  
 Tactiles  
 Tilt  
 Touch  
 Indicators  
 Accessories  
 Supplement

## RGB

### LED SPECIFICATIONS

The electrical specifications shown are determined at a basic temperature of 25°C.

LEDs are an integral part of the switch and are not available separately.

LED circuit is isolated and requires an external power source.

If the source voltage exceeds the rated voltage, a ballast resistor is required.

The resistor value can be calculated by using the formula in the Supplement Section.

Note: For applications that require white illumination, contact factory.

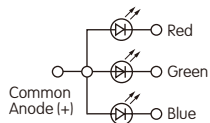

Color	Red	Green	Blue	Unit	
Maximum Forward Current	$I_{FM}$	50	30	30	mA
Typical Forward Current	$I_F$	15	16	10	mA
*Forward Voltage	$V_F$	2.0	2.9	2.9	V
Power Peak Dissipation	$P_D$	100	80	80	mW
Maximum Reverse Voltage	$V_{RM}$	5	5	5	V
Dominant Wavelength	$\lambda_d$	620	525	467	nm
Current Reduction Rate Above 25°C	$\Delta_{IF}$	0.75	0.25	0.22	mA/°C
Ambient Temperature Range	-25 ~ +50			°C	

### TYPICAL SWITCH DIMENSIONS

#### 12.0mm Square Cap with RGB LED

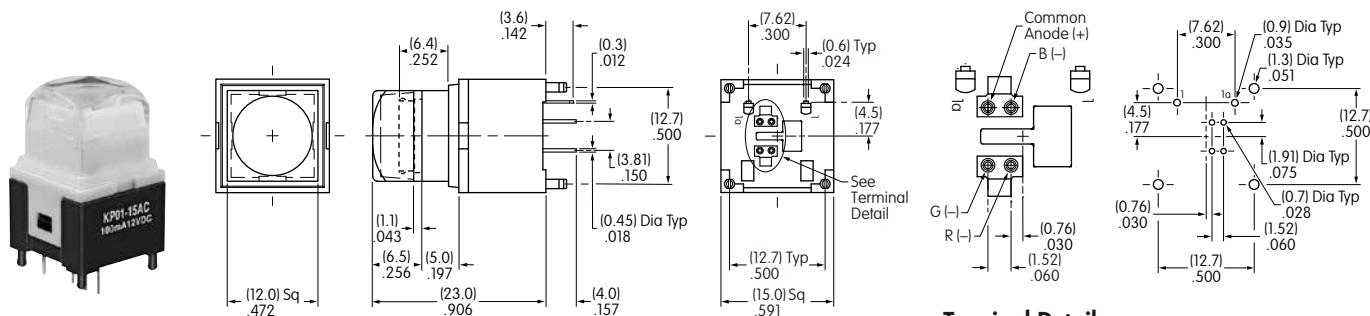

**KP0115ACAKG03RGB-1SJB**

#### 15.0mm & 17.4mm Square Caps with RGB LED

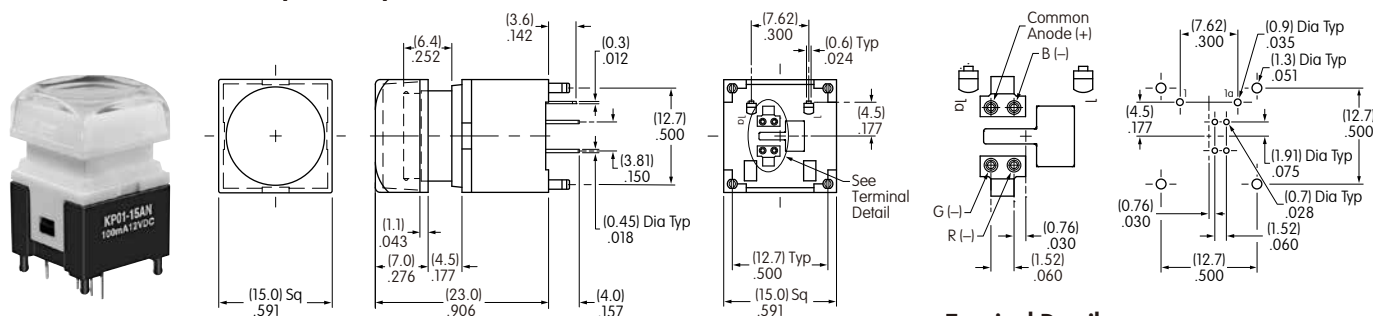

**KP0115ANBKG03RGB-2SJB**

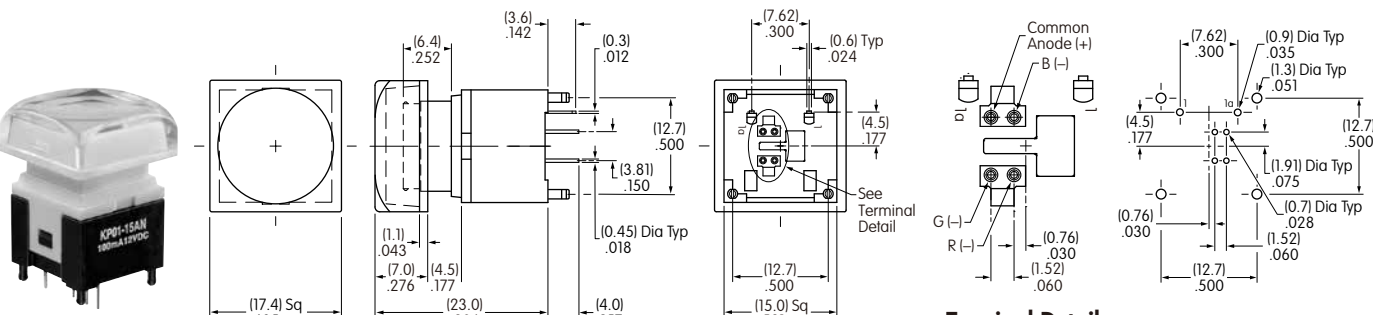

**KP0115ANBKG03RGB-3SJB**

RECTANGULAR CAP ASSEMBLY  
CAP ASSEMBLY DIMENSIONS

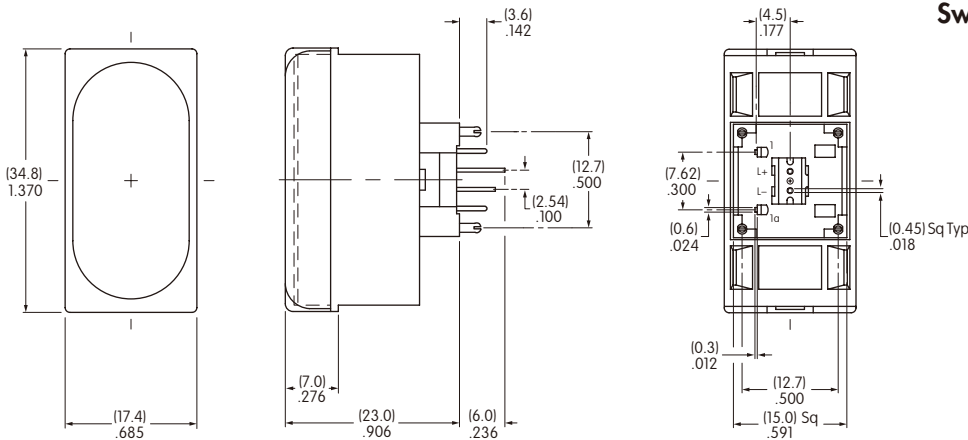

Switch/Rectangular Cap Assembly



KP0115ACBKG03CJB for Tactile  
KP0115ANBKG03CJB for Nontactile

See below for complete assembly of switch, LEDs and LED holders.

LED SPECIFICATIONS

The electrical specifications shown are determined at a basic temperature of 25°C. Center LED is an integral part of the switch. LEDs are not sold separately. LED circuits are isolated and require an external power source. If the source voltage exceeds the rated voltage, a ballast resistor is required. The resistor value can be calculated by using the formula in the Supplement Section.

	Color	Red	Unit
Maximum Forward Current	$I_{FM}$	30	mA
Typical Forward Current	$I_F$	20	mA
Forward Voltage	$V_F$	2.0	V
Maximum Reverse Voltage	$V_{RM}$	4	V
Dominant Wavelength	$\lambda_d$	623	nm
Current Reduction Rate Above 25°C	$\Delta I_F$	0.32	mA/°C
Ambient Temperature Range		-25 ~ +50	°C

Contact factory for other LED colors.

ASSEMBLY & INSTALLATION INSTRUCTIONS

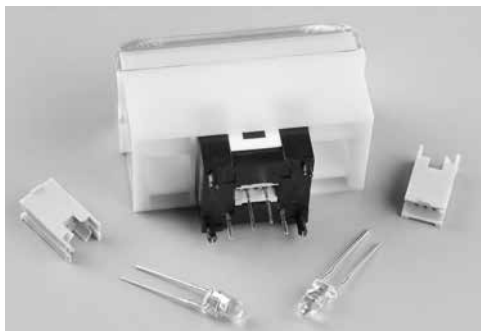

Switch/Rectangular Cap assembly has 3 LEDs to achieve bright and even illumination.

One LED (in center of switch bottom) is an integral part of the switch; the other 2 LEDs and 2 LED Holders are packaged separately.

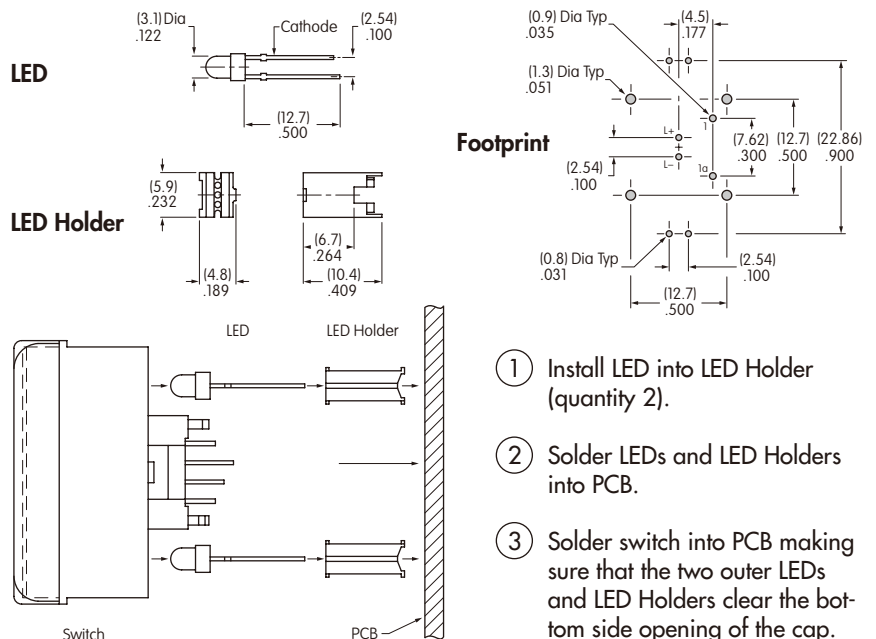

- 1 Install LED into LED Holder (quantity 2).
- 2 Solder LEDs and LED Holders into PCB.
- 3 Solder switch into PCB making sure that the two outer LEDs and LED Holders clear the bottom side opening of the cap.

### ASSEMBLY INSTRUCTIONS FOR SQUARE CAPS



#### Cap Orientation

As shown in the accompanying illustration, the cap and plunger are designed with tabs and notches to assure proper orientation of the cap on the switch.

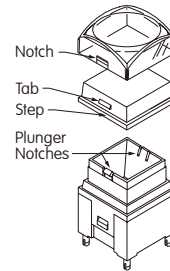

#### Removal of Cap Assembly & Separation of Lens & Diffuser

Holding the switch tightly, pull the cap off the switch. Once the cap assembly is released from the plunger, the lens and diffuser can be separated.

Pry up the lens with fingernail or flat tip screwdriver inserted at the step on the diffuser.

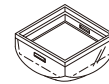

#### Installation or Replacement of Cap

After aligning notches with tabs, join the lens and diffuser. Hold the switch tightly without touching the terminals. Firmly press the cap onto the plunger by applying pressure from one side to the other until both are snapped together.

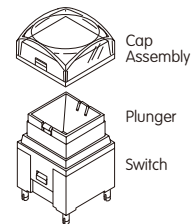

## LEGENDS

NKK Switches can provide custom legends for caps. Contact factory for more information.

### Suggested Printable Areas for KP Lens

#### Recommended Methods:

- Laser Etch on clear lens, Screen Print, or Pad Print on lens.
- Laser Print on film insert.
- Epoxy based ink is recommended.

Printing on Diffuser is not advisable.

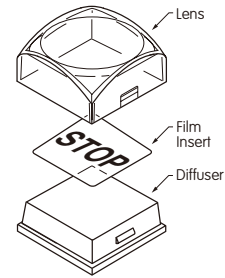

Shaded areas are suggested printable areas for Lens.

#### Rectangular Cap Lens

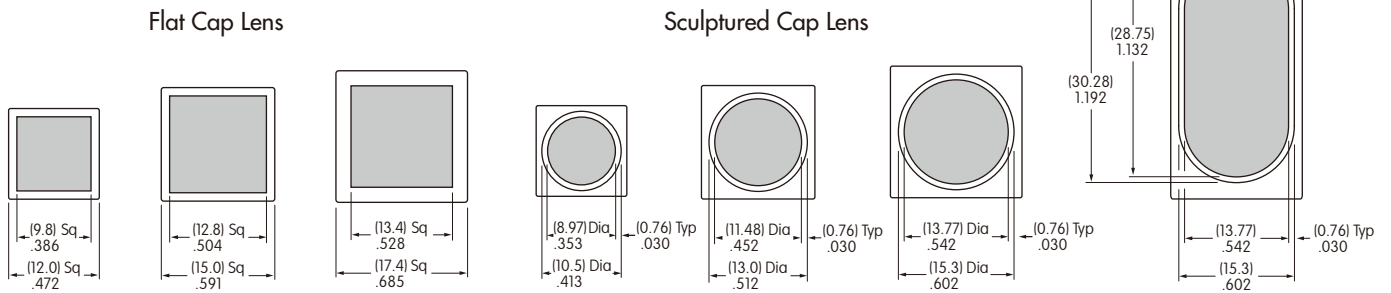

### Suggested Printable Areas for KP Film Insert

Shaded areas are suggested printable areas for Film Insert.

#### Rectangular Film Insert

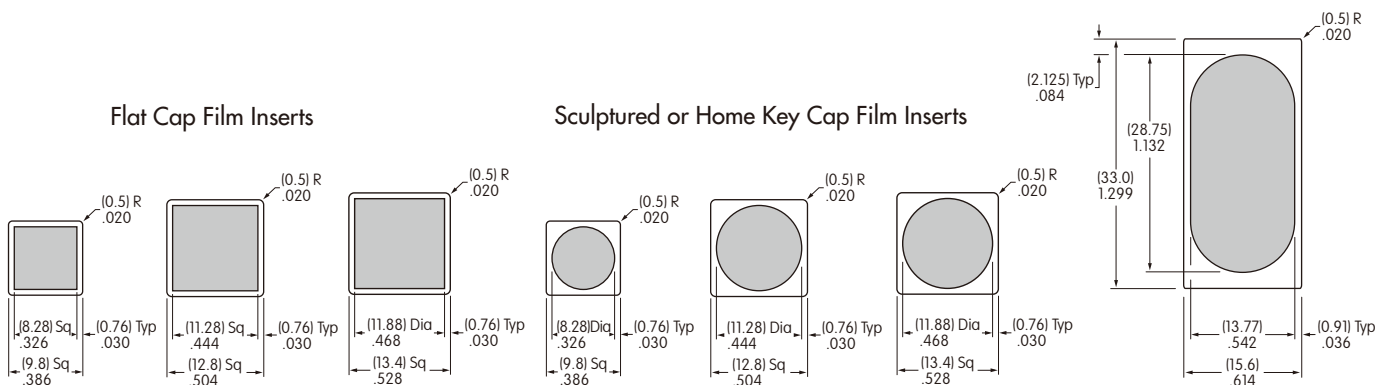

**Film Insert Material and Thickness:** Clear Polyester; 4 mil (100µ) maximum thickness