

DOUBLE BREAK, SNAP-ACTION, COMMERCIAL & MILITARY GRADES, SUBMINIATURE

### MIL-PRF-8805/76 (0.200 inches wide)

OTTO's B3-2XXXX series is a subminiature switch that is qualified to MIL-PRF-8805/76. Designed to switch at least one million mechanical cycles, the B3 surpasses the requirements of the military in these categories: contact resistance less than 25mΩ, contact bounce and overall cycle life. For MIL-PRF-8805/76 requirements, B3-22141 has standard silver with gold contacts, SPDT double break two circuit (Form Z), solder terminals in thermoset case material. Gold plated contacts are available for non-military applications. UL recognized models available.

### MIL-PRF-8805/101 (0.156 inches wide)

For your really difficult projects, try OTTO'S B3 series. They are qualified to the OTTO inspired MIL-PRF-8805/101 specification. Only 0.156" thick, think of all those extra 0.044" you can use in those tight ganged jobs. With the B3 series, you can get an extra pole in where only four MIL-PRF-8805/76's fit, with room to spare. Examine the characteristics. With the MIL-PRF-8805/101, the only thing you give up is the extra space the MIL-PRF-8805/76 takes. Cycle life, very low contact resistance, minimal contact bounce... everything is exactly as provided by the MIL-PRF-8805/76 specification.

For MIL-PRF-8805/101 requirements, B3-11141 (PC pin) and B3-12141 (turret) have silver with gold contacts and SPDT double break (Form Z) contact. For commercial applications, a variety of contact forms, special forces and gold plate contacts are available. Most versions are also UL recognized.

Great circuit versatility is available with either switch style. You have your choice of normally open (Form X) or closed (Form Y), 3 terminal (Form C) and 4 terminal (Form Z) SPDT double break.

## Features:

- Low level switching capability
- Less than 25mΩ initial contact resistance
- Up to 8 amps switching capability
- Button accepts actuation directly from a cam
- Choice of 0.156" & 0.200" wide models
- Choice of 6 standard terminal styles or wire leads
- Available in Commercial & Military grades
- Qualified to MIL-PRF-8805/76 & MIL-PRF-8805/101
- Momentary action
- UL recognized
- RoHS compliant

## APPLICATIONS

OTTO subminiature switches are designed to meet all applications requiring MIL-PRF-8805/76 or MIL-PRF-8805/101 switches. Basic switches are designed for miniature spaces where cam or other limit actuators are used. In addition, toggle, pushbutton and lever actuators are available.

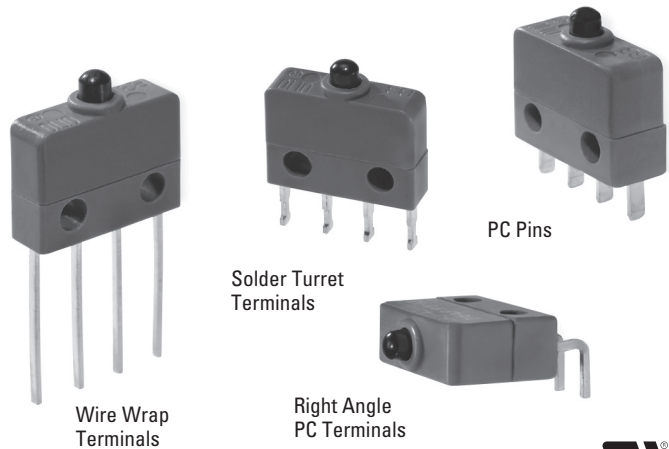

Standard Characteristics/Ratings:				
ELECTRICAL RATINGS:				
Circuitry	Load	Sea Level @ 28VDC	70,000 feet @ 28VDC	Sea Level @ 115VAC, 60/400Hz*
SPST-NO or NC	Resistive	8A	8A	8A
Form Z		5A	5A	5A
Form C		5A	5A	5A
Gold Contacts		5A	5A	N/A
SPST-NO or NC	Inductive**	5A	3A	5A
Form Z		3A	2A	3A
Form C		2.5A	1.5A	2.5A
Gold Contacts		3A	2A	3A
*Applies to commercial grade switches				
**L/R = 0.026				
Lamp		1A	N/A	1A
Motor		5A	N/A	
DWV		1000Vrms	400Vrms	
Low Level:	Gold contacts 10mA @ 30mV			
Electrical Life:	50,000 cycles at full load			
Mechanical Life:	1,000,000 cycles			
Seal:	Unsealed			
Operating Temp Range:	-65°C to +125°C			
Operating Force:	5 oz +/- 2 oz typical, 6 oz max, or 5 oz min options			
Release Force:	1.5 oz min			
Operate Point:	0.320 +/- 0.015 inches from mounting holes			
Overtravel:	0.004 inches min			
Movement Differential:	0.018 +/- 0.008 inches			
MATERIALS:				
Case:	Thermoset, blue			
Cover:	Thermoplastic, blue			
Button:	Thermoplastic, black			
Terminals:	Brass with gold			
Contacts:	Stationary: Silver with gold plate Moveable: Silver with gold plate			
Terminal Hardware:	None provided, optional wires			
Mounting Hardware:	None provided			

# SUBMINIATURE BASIC SWITCHES

DOUBLE BREAK, SNAP-ACTION, COMMERCIAL & MILITARY GRADES, SUBMINIATURE

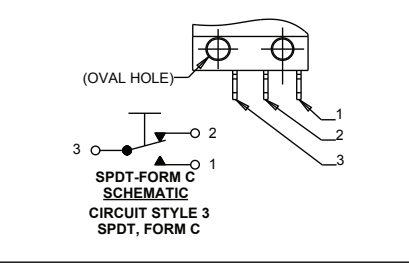
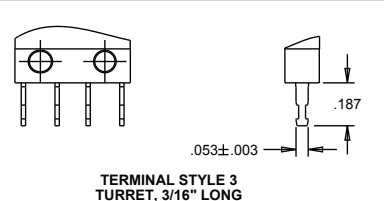
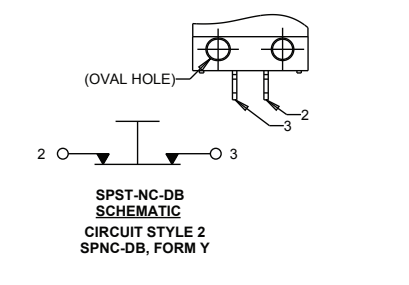
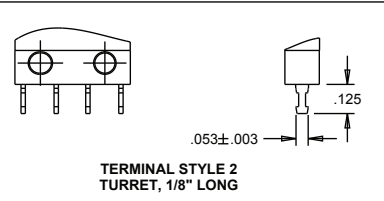
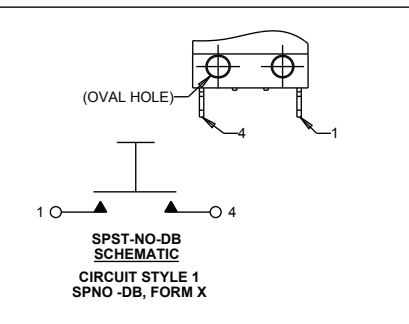
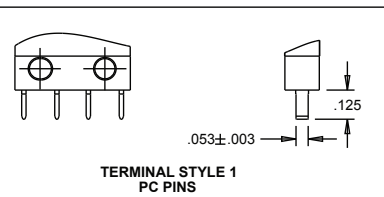
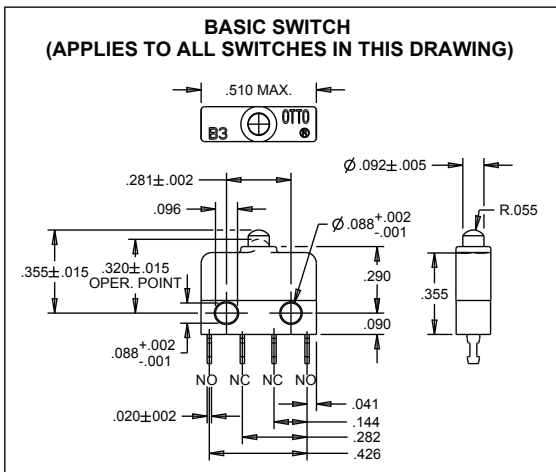

**MODEL (WIDTH/CONSTRUCTION) 1  
0.156" (MILITARY GRADE)**

MILITARY NO.	OTTO NO.
M8805/101-015	B3-11131
M8805/101-017	B3-12131
M8805/101-021	B3-13131
M8805/101-019	B3-15131
M8805/101-016	B3-11132
M8805/101-018	B3-12132
M8805/101-022	B3-13132
M8805/101-020	B3-15132
M8805/101-007	B3-11141
M8805/101-009	B3-12141
M8805/101-013	B3-13141
M8805/101-011	B3-15141
M8805/101-008	B3-11142
M8805/101-010	B3-12142
M8805/101-014	B3-13142
M8805/101-012	B3-15142

Dimensions: .156<sup>+0.000</sup>-.005 (width)

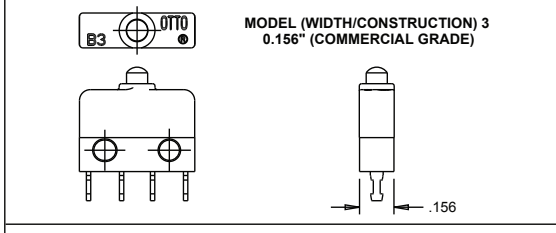
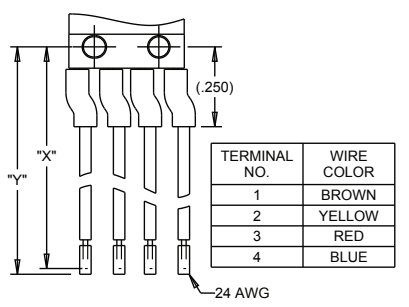
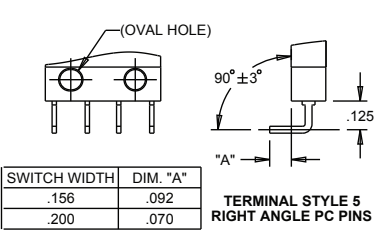
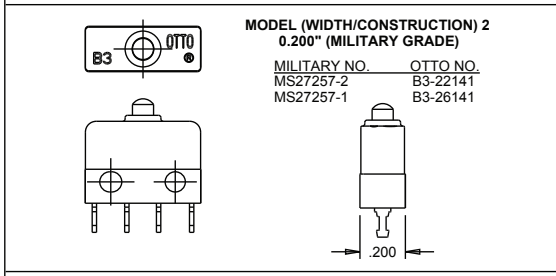
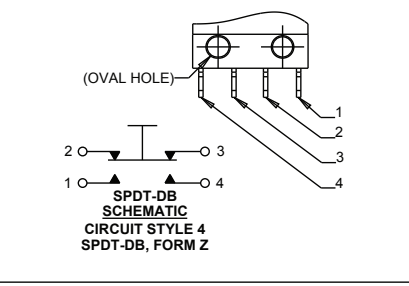
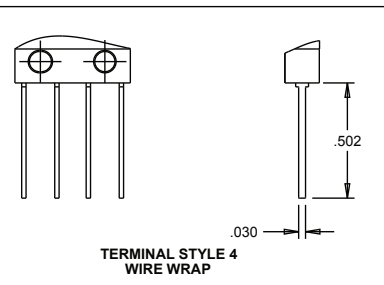

**WIRE LENGTH FOR A, B, C, & D**

WIRE LENGTH CODE	DIM. "X"	DIM. "Y"
A	06.00±.38	06.09±.38
B	12.00±.50	12.09±.50
C	18.00±.50	18.09±.50
D	24.00±.50	24.09±.50
E	30.00±.75	30.09±.75

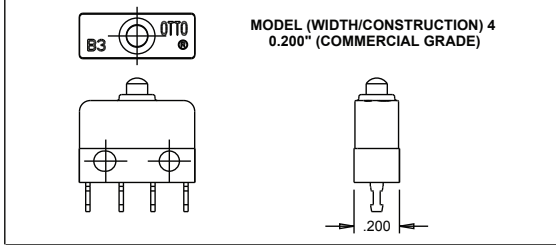

DOUBLE BREAK, SNAP-ACTION, COMMERCIAL & MILITARY GRADES, SUBMINIATURE

**CONTACT CONFIGURATIONS:**

MIL-PRF-8805/76 and MIL-PRF-8805/101 specify single pole, double throw, double break (Form Z) contact configuration. Available and included in the military specifications are SPNO and SPNC double break, (Form X and Y). The MIL-PRF-8805/101 also specifies SPDT Form C.

**MILITARY APPROVALS**

(MIL-PRF-8805/76 & MIL-PRF-8805/101)

Certain OTTO B3 models have been qualified to the military specification for these parts. The following is a partial listing. Consult the Cross Reference that appears at the back of this catalog for the latest, complete listings.

MILITARY NO.	OTTO P/N	MILITARY NO.	OTTO P/N
MS27257-1	B3-26141	M8805/101-011	B3-15141
MS27257-2	B3-22141	M8805/101-012	B3-15142
M8805/101-001	B3-10064	M8805/101-013	B3-13141
M8805/101-002	B3-10065	M8805/101-014	B3-13142
M8805/101-003	B3-10066	M8805/101-015	B3-11131
M8805/101-004	B3-10067	M8805/101-016	B3-11132
M8805/101-005	B3-10063	M8805/101-017	B3-12131
M8805/101-006	B3-10072	M8805/101-018	B3-12132
M8805/101-007	B3-11141	M8805/101-019	B3-15131
M8805/101-008	B3-11142	M8805/101-020	B3-15132
M8805/101-009	B3-12141	M8805/101-021	B3-13131
M8805/101-010	B3-12142	M8805/101-022	B3-13132

**Auxiliary Lever Actuators for B3**

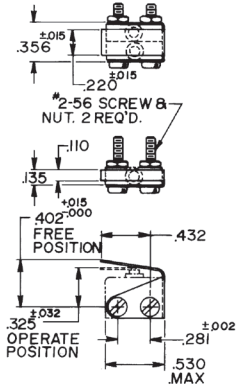
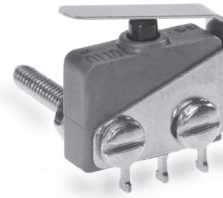

Catalog Number	Number of Poles
A1-101-02	1
A3-102	2

Supplied with two 2-56 panhead screws, hex nuts and lockwashers.

For additional options, contact factory.

**ORDERING INFORMATION:**

**B3 Basic**

Select the OTTO B3 basic switch to match your specific circuit and mechanical requirements. To order, specify your requirement using the OTTO Part Number Code shown below.

**Example:** B3-12141 is 0.156" wide, has 1/8" long turret terminals, 5 oz operating force, SPDT double break and silver/gold contacts (MIL-PRF-8805/101).

**B3 PART NUMBER CODE**

**Bold Code** items signify conformance to MIL-PRF-8805 specifications.

**B3** - **X**

**Model**

- 1. 0.156" (MIL Grade)
- 2. 0.200" (MIL Grade)
- 3. 0.156" (Com'l Grade)
- 4. 0.200" (Com'l Grade)

**X**

**Terminal Style or Wire Length**

- 1. PC Pins
- 2. Turret, 1/8" lg.
- 3. Turret, 3/16" lg.
- 4. Wire Wrap
- 5. Right Angle PC Pins
- 6. Solder ①
  - A. With Wires 06.0" lg.
  - B. With Wires 12.0" lg.
  - C. With Wires 18.0" lg.
  - D. With Wires 24.0" lg.
  - E. With Wires 30.0" lg.

**X**

**Operating Force**

- 1. 5<sup>+3</sup>/<sub>-2</sub> oz
- 2. 5 oz min
- 3. 6 oz max

**X**

**Circuitry**

- 1. SPNO-DB, Form X
- 2. SPNC-DB, Form Y
- 3. SPDT, Form C
- 4. SPDT-DB, Form Z

**X**

**Contact Material**

- 1. Silver/Gold – High Current
- 2. Silver/Gold – Low Current

① Available on 0.200" wide models only.

Your official representative

**ALDERS**<sup>®</sup>

Indicate. Control. Connect.

**ALDERS electronic GmbH**  
Arnoldstraße 19  
47906 Kempen - Germany  
+49 2152 8955-0  
[sales@alders.de](mailto:sales@alders.de) / [www.alders.de](http://www.alders.de)