

RUGGED DESIGN

Cast from aluminum alloy, the G2 Commander Grip is a rugged industrial control grip suitable for demanding applications. The standard G2 Commander Grip offers nine different faceplate configurations that include pushbutton, toggle, transducer, split trim and Hall effect switches. Thousands of custom faceplate configurations are possible. The grip body has 10 possible switch location options.

The G2 Commander Grip is suitable for use in military, aerospace and industrial applications, and is the ideal solution where durability and dependability are required.

Features:

- **Standard design eliminates the need for tooling charges**
- **Available as a fixed grip or can be mounted on an OTTO Hall effect joystick**
- **Various mounting & termination options available**
- **Nine standard faceplate configurations that collectively include OTTO's T3, T4 and T5 toggle switches, P4, P7 and P9 pushbutton switches, K1 rocker switches, SPT split trim switches, J2 transducer switches, FG flip guards, and HTWM, HTL and HTLT Hall effect controls.**
- **Thousands of custom faceplate configurations possible that can accommodate virtually all OTTO pushbutton, rocker, toggle, trim, transducer and thumbwheel switches**
- **Operator presence and trigger options**
- **USB output option**
- **Tested to withstand a 265 lb. load**
- **Grip sealed to IP68S (subject to change based on switch choice)**



Commander Grip with Brow Shown

Standard Physical Characteristics:

MATERIALS:	
Handle:	Aluminum, investment cast, A356-T6
Faceplate:	Aluminum, wrought, 6061-T6
Wires (Flying Leads):	22 AWG per M22759/11-22
Wires (USB Cable)	USB 2.0 type A connector

G2 COMMANDER GRIP PART NUMBER CODE

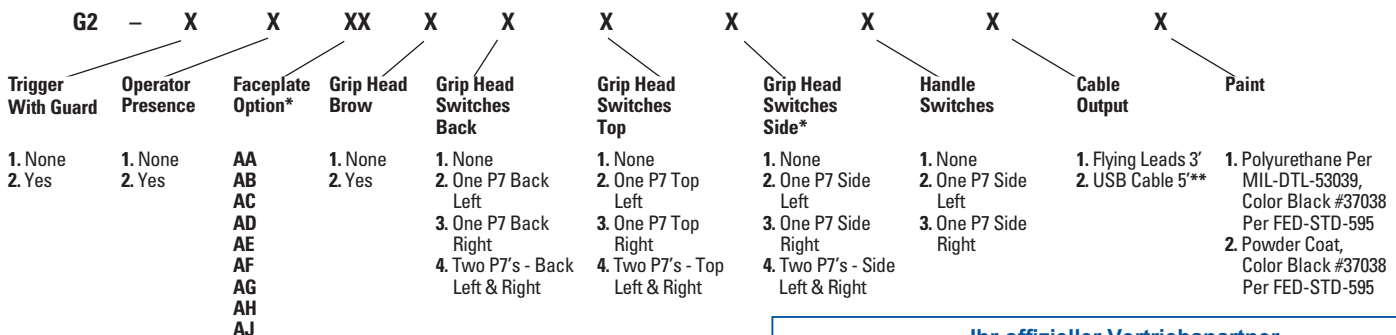

* See Faceplate Configurations on Pages 33-34.
Faceplate options AB, AD and AH not available with grip head switches side, option 2 & 4.
Faceplate options AE and AF not available with grip head switches side, option 3 & 4.
**Faceplate options AC and AF not available with USB Cable Output option.

Ihr offizieller Vertriebspartner

ALDERS®
Indicate. Control. Connect.

ALDERS electronic GmbH
Arnoldstraße 19
47906 Kempen

+49 2152 8955-0
vertrieb@alders.de / www.alders.de

RUGGED DESIGN

STANDARD DIMENSIONS

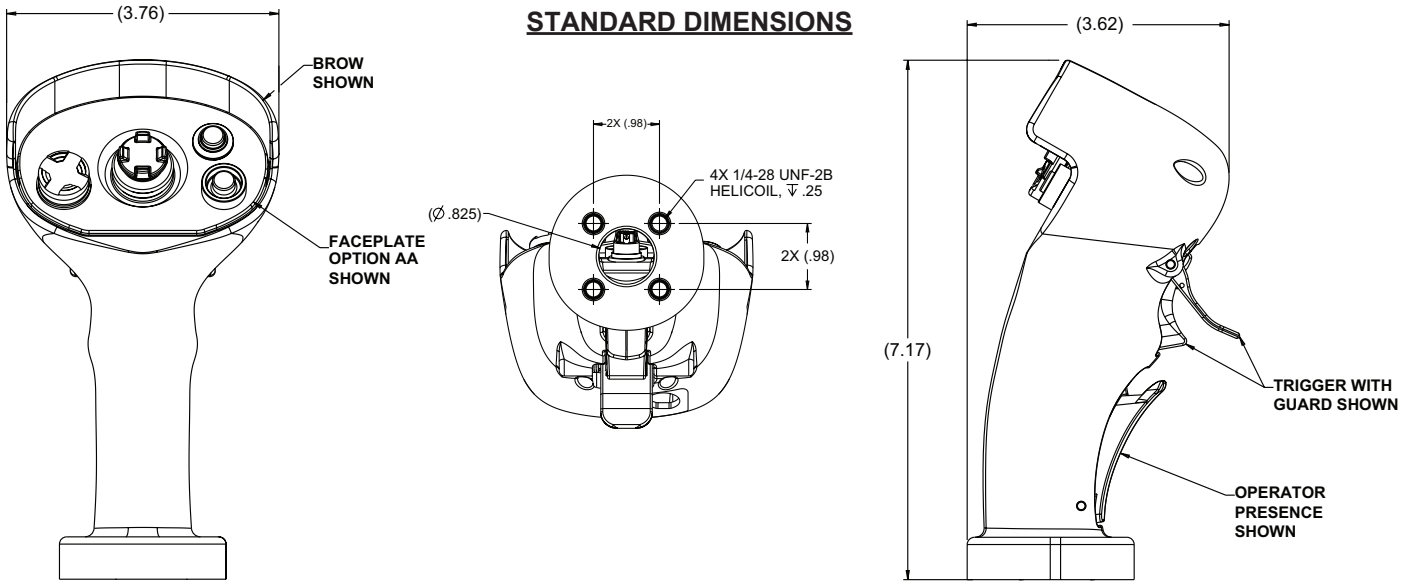

GRIP HEAD AND HANDLE SWITCH OPTIONS

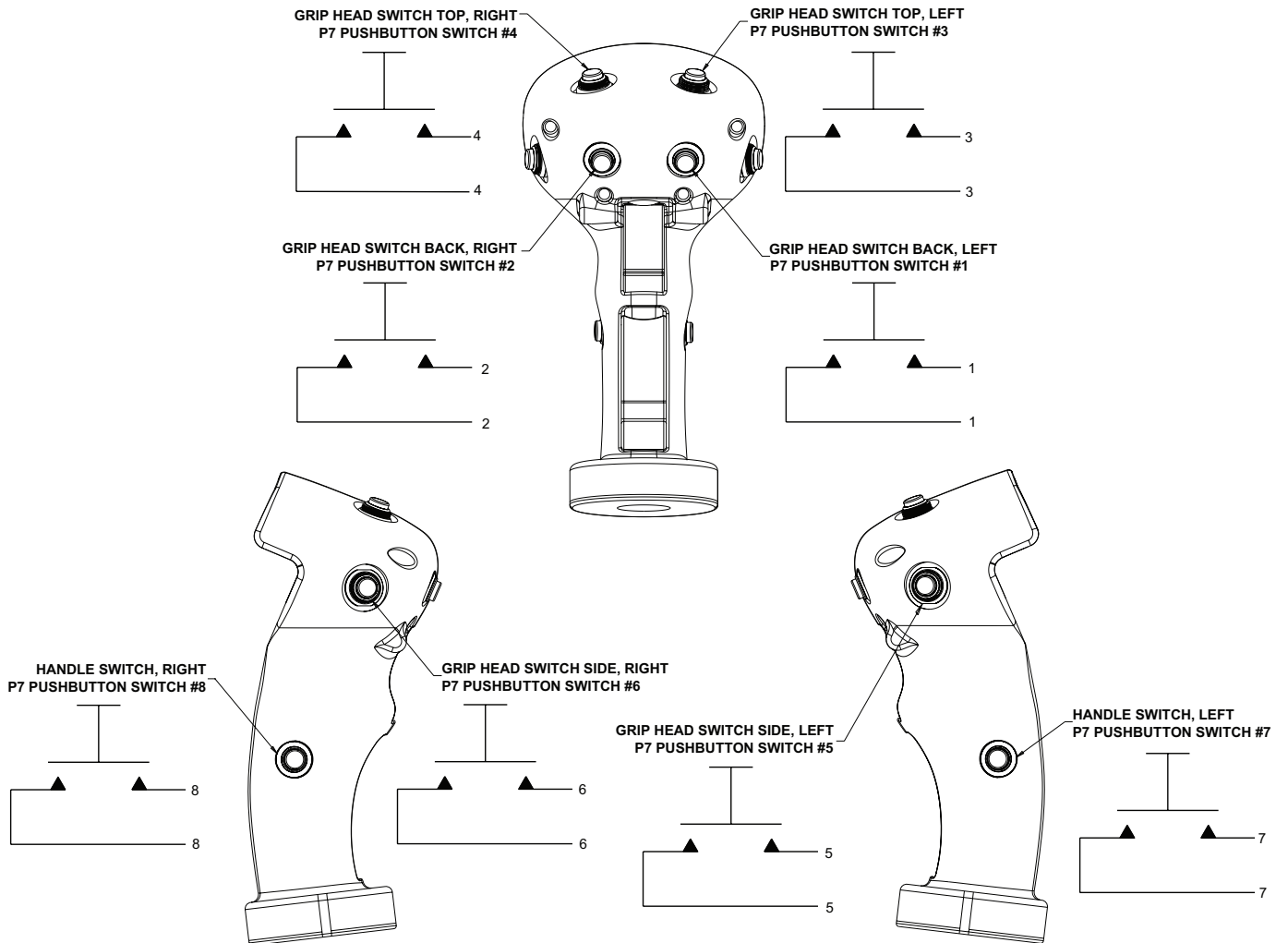

TRIGGER, BROW AND OPERATOR PRESENCE OPTIONS

TRIGGER OPTIONS

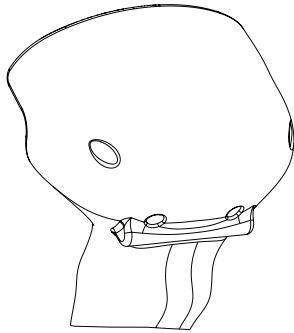

NO TRIGGER

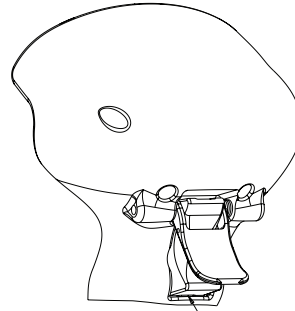

P4 PUSHBUTTON SWITCH

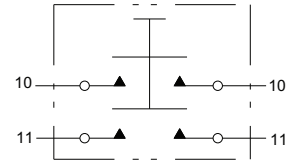

TRIGGER WITH GUARD

OPERATOR PRESENCE OPTIONS

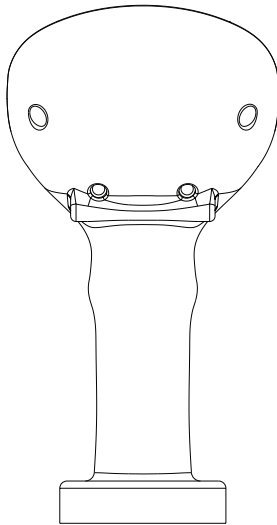

NO OPERATOR PRESENCE

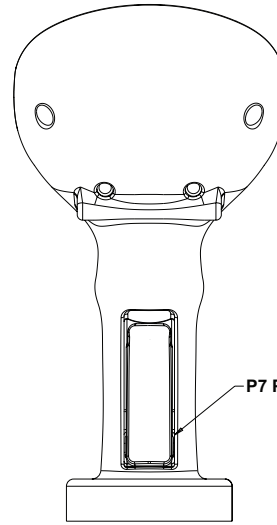

P7 PUSHBUTTON SWITCH #9

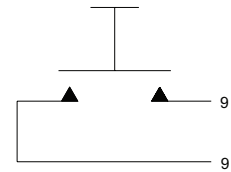

OPERATOR PRESENCE

BROW OPTIONS

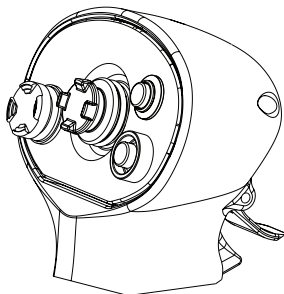

NO BROW

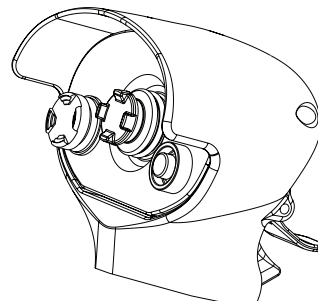

WITH BROW

STANDARD CONFIGURABLE FACEPLATE OPTIONS

FACEPLATE OPTIONS

HTL4 HALL EFFECT SWITCH

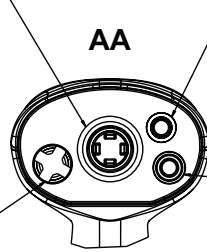
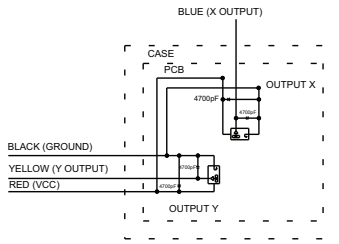

P7 PUSHBUTTON SWITCH

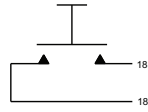

P7 PUSHBUTTON SWITCH

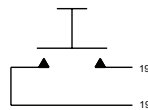

T5 TOGGLE SWITCH

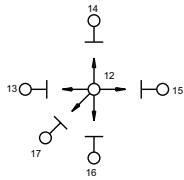

HTL4 HALL EFFECT SWITCH

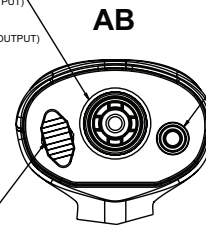
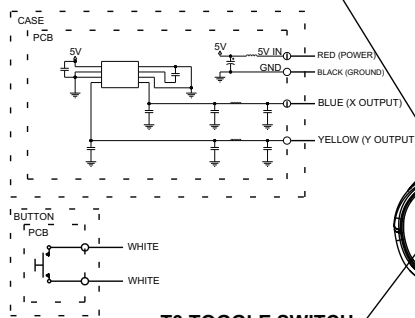

P7 PUSHBUTTON SWITCH

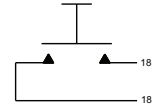

T3 TOGGLE SWITCH

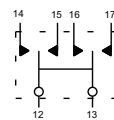

J2 TRANSDUCER SWITCH

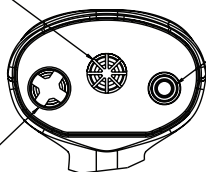
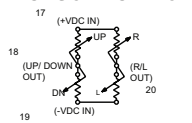

P7 PUSHBUTTON SWITCH

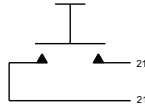

T4 TOGGLE SWITCH

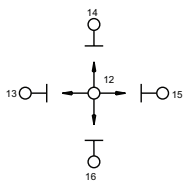

T5 TOGGLE SWITCH

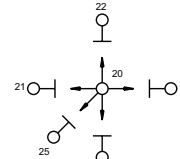

AD

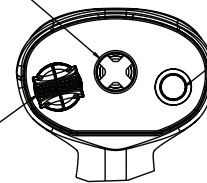

P7 PUSHBUTTON SWITCH

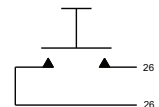

SPT SPLIT TRIM SWITCH

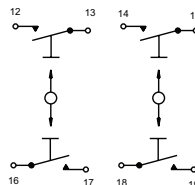

STANDARD CONFIGURABLE FACEPLATE OPTIONS

FACEPLATE OPTIONS

