

LINEAR HALL EFFECT FINGER JOYSTICK

2 & 4-WAY LINEAR HALL EFFECT FINGER JOYSTICK



HTL4 with External
Castle Boot Style
Button



HTL2 with Tall
Concave Stadium
Boot Style Button

The HTL series provides all of the performance of a full size, dual axis joystick in a miniature package that can be mounted in control handles, armrests and panels. The Hall effect sensors are immune to electromagnetic and radio frequency interference up to 100V/M. Programmable sensors with built-in temperature compensation ensure consistent and repeatable operation. The HTL series has excellent tactile feel for improved operator control and is available with either dusttight or IP68S watertight seal. A wide variety of output configurations are available to satisfy different applications.

Features:

- Designed for grip, armrest & panel mounting
- Proven contactless analog output Hall effect technology
- Redundant outputs available
- 1 million cycles
- Electronics watertight to IP68S
- Outstanding EMI/RFI immunity
- Variety of button styles
- Tighter center tolerance options
- RoHS compliant
- PWM output option

Standard Characteristics/Ratings:

MECHANICAL:

Mechanical Life: 1,000,000 all directions

Travel Angle: 23° min to 27° max, 25° typical

Operating Force with Boot: 16 oz typical to 20 oz max (at top of button) @ 20°C

Max Allowable Vertical & Radial Force on Button: 25.0 lbs.

Max Allowable Torque on Button about Shaft Axis: 5.5 lbs.

ELECTRICAL RATINGS:

HTL2: Rated at Vcc = 5V @ 20°C Load = 1mA (4.7KΩ)

Electrical	Units	Min	Typ	Max
Supply Voltage	VDC	4.50	5.00	5.50
Output Voltage Tolerance at Center AA, BB, CC, DD, EE, FF, GG & HH @ 5V Vcc	VDC	-0.25	N/A	+0.25
Output Voltage Tolerance at Center AT, BT, CT, DT, ET and FT @ 5V Vcc	VDC	-0.15	N/A	+0.15
Output Voltage Tolerance at Full Travel (see graph for output values) @ 5V Vcc	VDC	-0.25	N/A	+0.25
Supply Current per Sensor B=0, Vcc=5V, Iout=0	mA	N/A	N/A	10.00
Output Source Current Limit B=-X*, Vo=0	mA	-1.00	N/A	1.00

HTL4: Rated at Vcc = 5V @ 20°C Load = 1mA (4.7KΩ)

Electrical	Units	Min	Typ	Max
Supply Voltage	VDC	4.50	5.00	5.5
Output Voltage Tolerance at Center AA, BB, CC, DD, EE, FF, GG & HH @ 5V Vcc	VDC	-0.25	N/A	+0.25
Output Voltage Tolerance at Center AT, BT, CT, DT, ET and FT @ 5V Vcc	VDC	-0.15	N/A	+0.15
Output Voltage Tolerance at Full Travel (see graph for output values) @ 5V Vcc	VDC	-0.25	N/A	+0.25
Supply Current per Sensor B=0, Vcc=5V, Iout=0	mA	N/A	N/A	10.00
Output Source Current Limit B=-X*, Vo=0	mA	-1.00	N/A	1.00

ELECTRONICS

Seal Integrity: Electronics IP68S

ENVIRONMENTAL:

Operating Temp Range: -40°C to +85°C

Storage Temp Range: -40°C to +85°C

RFI: Withstand per SAE J1113

EMI: Withstand per SAE J1113

MATERIALS:

Boot: Elastomer

Button: Thermoplastic, black

Case: Thermoplastic, black

Flange: Thermoplastic, black

Wires: 22 or 24 AWG

Mounting Hardware: Panel fastener assembly

2 & 4-WAY LINEAR HALL EFFECT TOGGLE

HTL2 PART NUMBER CODE

HTL2	-	X	X	X	X	X	XX	X	X
Button Style	Case Style	Seal	Travel	Detent	Operating Force	Output 1 ①	Output 2 ②	Termination	Button Color
1. Castle	1. 0.970" SQ.	1. Dusttight	1. 25°	1. None	1. 16 oz	AA. 2.5 +/- 2.0VDC	NONE	1. Wire Leads	2. Black
2. External Castle Boot		2. Watertight Panel Seal*		2. Detent at 50% travel (not available with button style 7)		BB. 2.5 +/- 2.0VDC	2.5 +/- 2.0VDC	22 AWG, UL 1569	
3. Short Double Stadium						CC. 2.5 +/- 2.0VDC	2.5 +/- 2.0VDC	2. Pins	
4. Tall Concave Stadium						DD. 2.5 +/- 1.5VDC	NONE	3. Wire Leads	
5. External Bat Handle Boot						EE. 2.5 +/- 1.5VDC	2.5 +/- 1.5VDC	24 AWG, SAE AS22759	
6. External Smooth Boot						FF. 2.5 +/- 1.5VDC	2.5 +/- 1.5VDC		
7. Long Concave Y Axis Button						GG. 0.5 - 4.5VDC	0.5 - 4.5VDC		
8. Low Profile Button						HH. 1.0 - 4.0VDC	1.0 - 4.0VDC		
						AT. 2.5 +/- 2.0VDC	NONE**		
						BT. 2.5 +/- 2.0VDC	2.5 +/- 2.0VDC**		
						CT. 2.5 +/- 2.0VDC	2.5 +/- 2.0VDC**		
						DT. 2.5 +/- 1.5VDC	NONE**		
						ET. 2.5 +/- 1.5VDC	2.5 +/- 1.5VDC**		
						FT. 2.5 +/- 1.5VDC	2.5 +/- 1.5VDC**		



Ihr offizieller Vertriebspartner
ALDERS electronic GmbH
Arnoldstraße 19
47906 Kempen - Germany
+49 2152 8955-0
vertrieb@alders.de

HTL4 PART NUMBER CODE

HTL4	-	X	X	X	X	X	XX	X	X
Button Style	Case Style	Seal	Travel	Gating***	Operating Force	Output 1 ①	Output 2 ②	Termination	Button Color
1. Castle	1. 0.970" SQ.	1. Dusttight	1. 25°	1. Omnidirectional; Square; On-Axis and Off-Axis Guided Feel	1. 16 oz	AA. 2.5 +/- 2.0VDC	NONE	1. Wire Leads	2. Black
2. External Castle Boot		2. Watertight Panel Seal*		2. Gated; Two Axis Return to Center		BB. 2.5 +/- 2.0VDC	2.5 +/- 2.0VDC	22 AWG, UL 1569	
3. Short Double Stadium				3. Omnidirectional; Round; Smooth Feel		CC. 2.5 +/- 2.0VDC	2.5 +/- 2.0VDC	2. Pins	
4. Tall Concave Stadium				4. Omnidirectional; Round; On-Axis Guided Feel		DD. 2.5 +/- 1.5VDC	NONE	3. Wire Leads	
5. External Bat Handle Boot				5. Omnidirectional; Square; On-Axis and Off-Axis Guided Feel with Detent at 50% Travel		EE. 2.5 +/- 1.5VDC	2.5 +/- 1.5VDC	24 AWG, SAE AS22759	
6. External Smooth Boot				6. Omnidirectional; Round; Smooth Feel with Detent at 50% Travel		FF. 2.5 +/- 1.5VDC	2.5 +/- 1.5VDC	4. Wire Leads	
				7. Omnidirectional; Round; On-Axis Guided Feel with Detent at 50% Travel		GG. 0.5 - 4.5VDC	0.5 - 4.5VDC	22 AWG, UL 1569	
						HH. 1.0 - 4.0VDC	1.0 - 4.0VDC	shared powers and grounds (see schematic)	
						AT. 2.5 +/- 2.0VDC	NONE**	5. Wire Leads	
						BT. 2.5 +/- 2.0VDC	2.5 +/- 2.0VDC**	24 AWG, SAE AS22759	
						CT. 2.5 +/- 2.0VDC	2.5 +/- 2.0VDC**	shared powers and grounds (see schematic)	
						DT. 2.5 +/- 1.5VDC	NONE**		
						ET. 2.5 +/- 1.5VDC	2.5 +/- 1.5VDC**		
						FT. 2.5 +/- 1.5VDC	2.5 +/- 1.5VDC**		

* Watertight panel seal option available with button styles 2, 5, and 6.
 ** Options AT, BT, CT, DT, ET and FT are identical to options AA, BB, CC, DD, EE and FF respectively except with a tighter center tolerance.
 ***Gating options 5, 6 and 7 not available with button style 7.
 ① Outputs are from the center to the full travel position in each direction. Options "AA," "BB," "CC," "DD," "EE," and "FF" provide increased voltage in +Y; and decreasing voltage in -Y direction from one output per axis with the HTL2 and increased voltage in +X, +Y; and decreasing voltage in -X, -Y direction from one output per axis with the HTL4. Options "GG" and "HH" provide increasing voltages in all directions (+Y, -Y with the HTL2 and +X, +Y, -X, -Y with the HTL4) from 2 outputs per axis.
 ② Options "BB" and "EE" provide redundant output 2 which duplicates output 1. Options "CC" and "FF" provide redundant output 2 which is inverse of output 1.

Gating Icons



Omnidirectional Square On-Axis and Off-Axis Guided Feel****

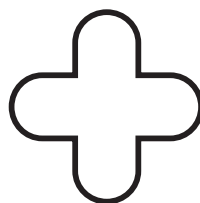

Gated Two Axis Return to Center

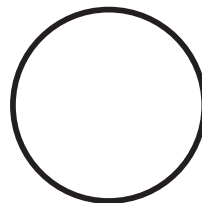

Omnidirectional Round Smooth Feel



Omnidirectional Round On-Axis Guided Feel****



Single Axis (HTL2 version)

****Feel defined by shading.

LINEAR HALL EFFECT FINGER JOYSTICK

HTL
HALL EFFECT
JOYSTICK

2 & 4-WAY LINEAR HALL EFFECT TOGGLE

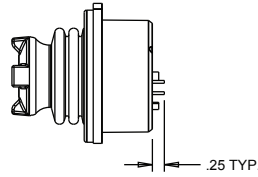
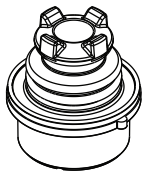

PINS NOT PRESENT
IN ALL CONFIGURATIONS

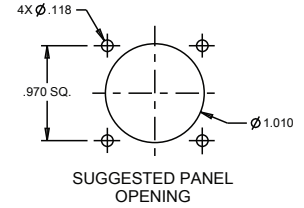
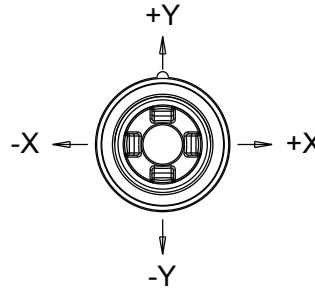
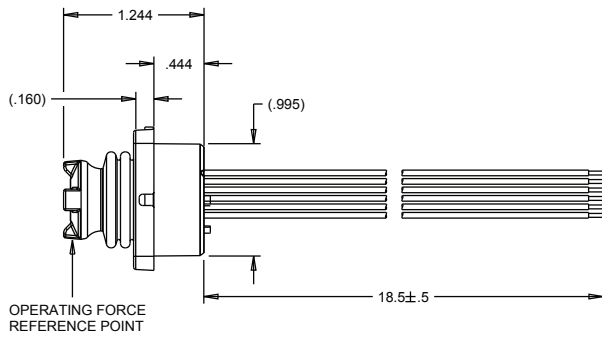
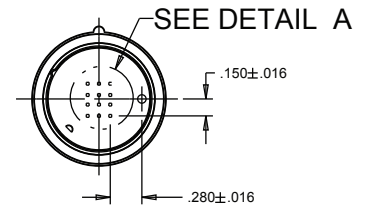
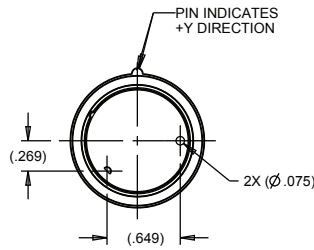

SUGGESTED PANEL
OPENING

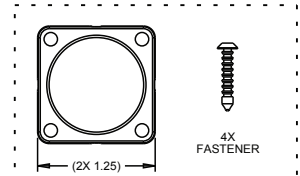

SHIPPED UNASSEMBLED

HTL2 FOOTPRINT

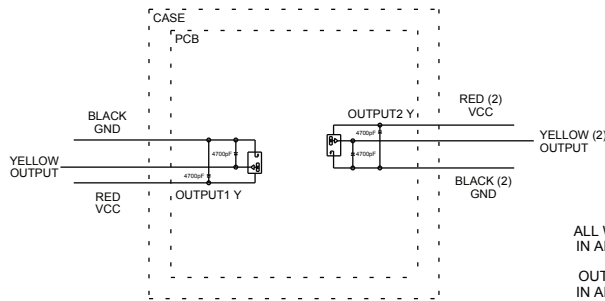

ALL WIRES NOT PRESENT
IN ALL CONFIGURATIONS
OUTPUT2 NOT PRESENT
IN ALL CONFIGURATIONS

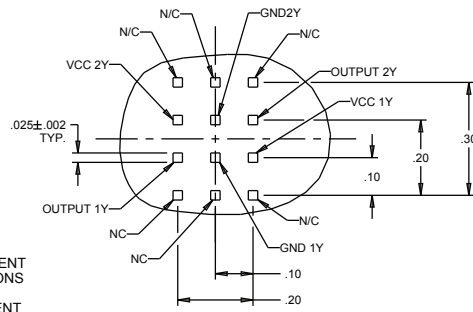

DETAIL A

ALL PINS NOT PRESENT IN ALL CONFIGURATIONS

HTL4 FOOTPRINT

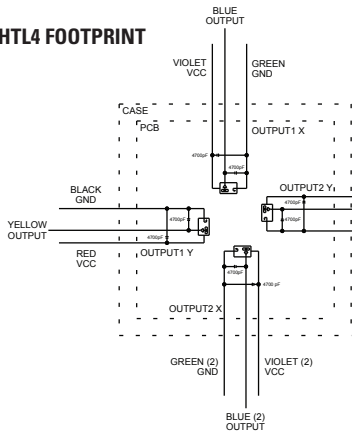

TERMINATION STYLE 1, 2, AND 3

ALL WIRES NOT PRESENT
IN ALL CONFIGURATIONS
OUTPUT2 NOT PRESENT
IN ALL CONFIGURATIONS

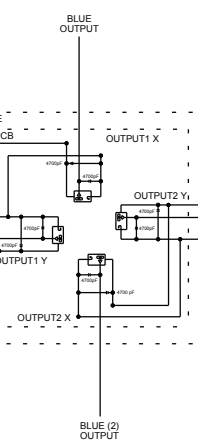

TERMINATION STYLE 4 AND 5

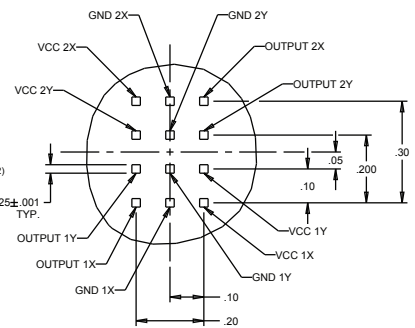

DETAIL A

ALL PINS NOT PRESENT IN ALL CONFIGURATIONS

2 & 4-WAY LINEAR HALL EFFECT TOGGLE

HTL2 OUTPUTS

OPTION AA & AT

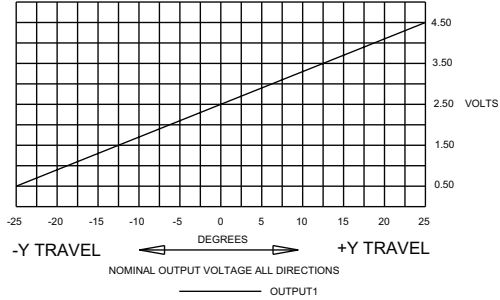

OPTION BB & BT

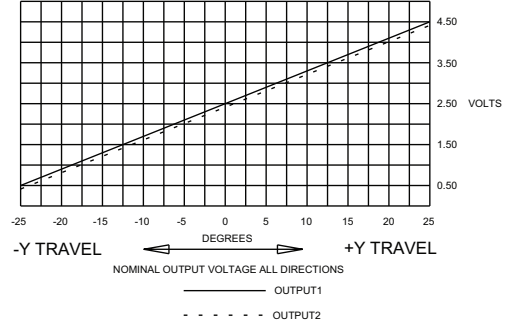

OPTION CC & CT

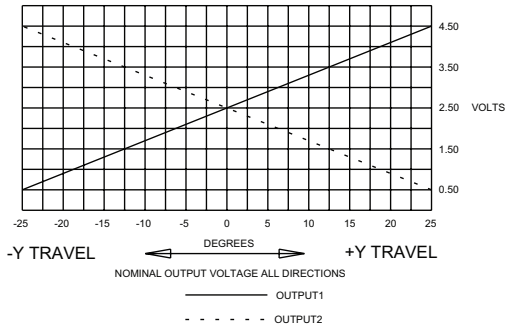

OPTION DD & DT

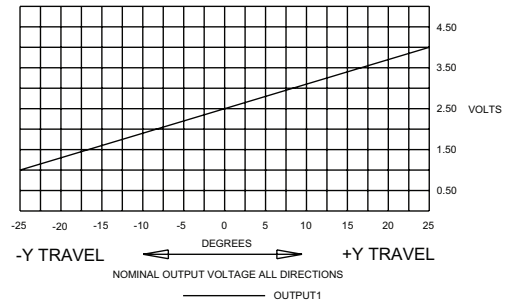

OPTION EE & ET

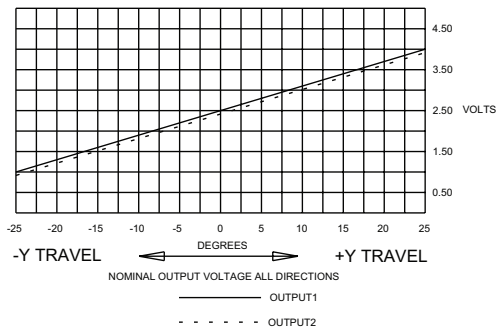

OPTION FF & FT

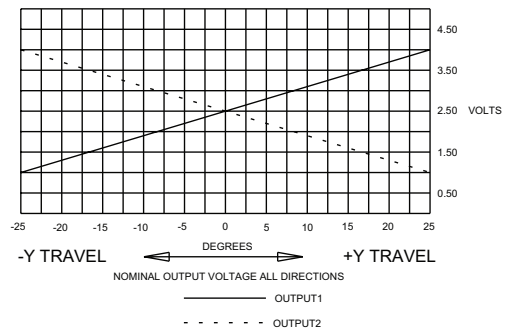

OPTION GG

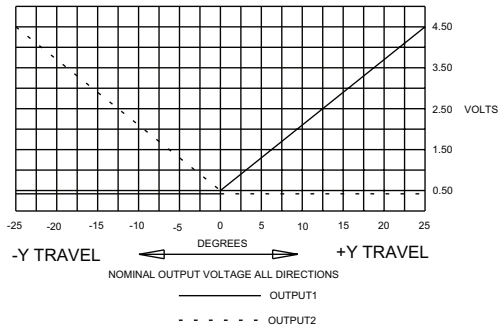

OPTION HH

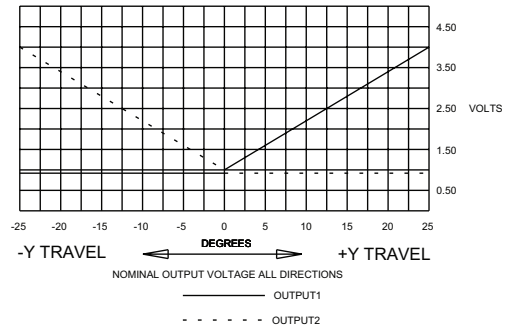

2 & 4-WAY LINEAR HALL EFFECT TOGGLE

HTL4 OUTPUTS

OPTION AA & AT

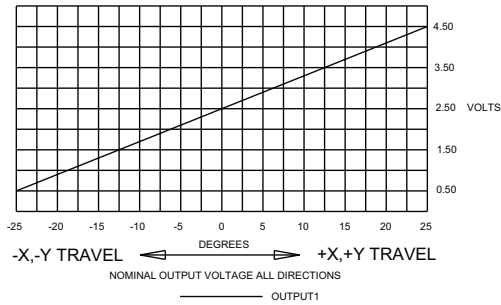

OPTION BB & BT

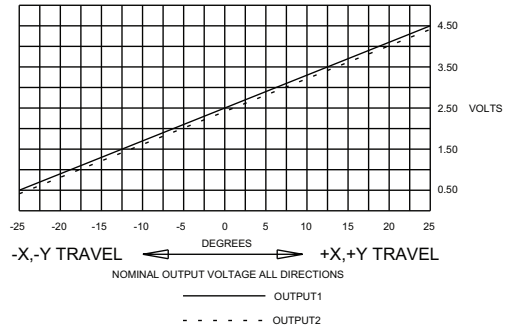

OPTION CC & CT

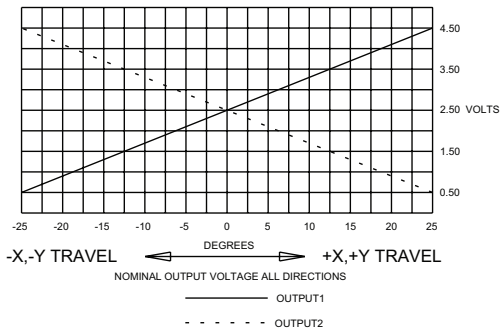

OPTION DD & DT

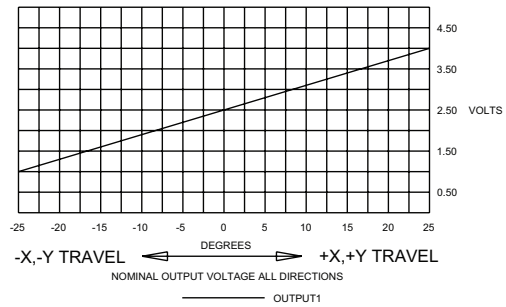

OPTION EE & ET

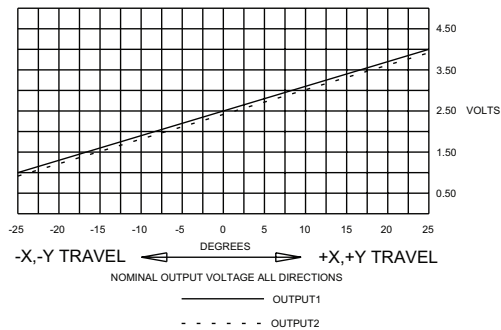

OPTION FF & FT

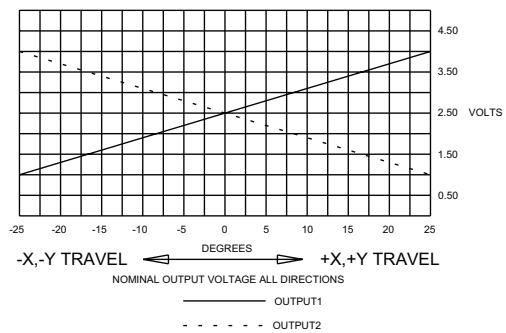

OPTION GG

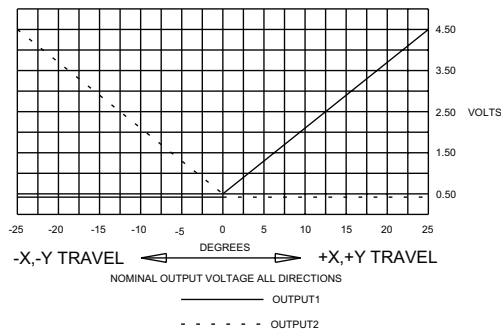

OPTION HH

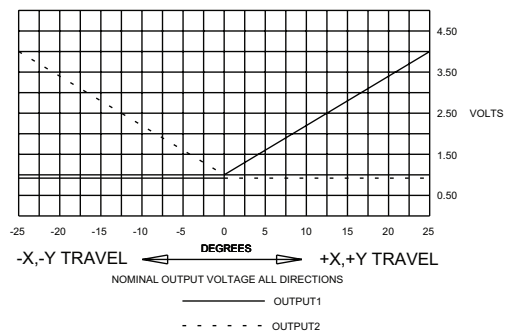

BUTTON CONFIGURATIONS

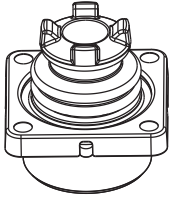

BUTTON STYLE 1
(CASTLE)

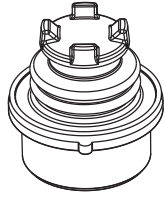

BUTTON STYLE 2
(EXTERNAL CASTLE BOOT)

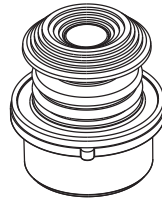

BUTTON STYLE 3
(SHORT DOUBLE STADIUM)

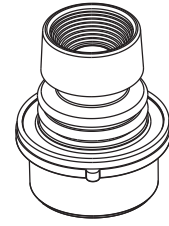

BUTTON STYLE 4
(TALL CONCAVE STADIUM)

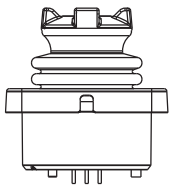

BUTTON STYLE 5
(EXTERNAL BAT
HANDLE BOOT)

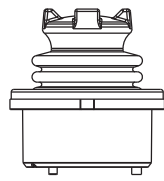

BUTTON STYLE 6
(EXTERNAL SMOOTH BOOT)

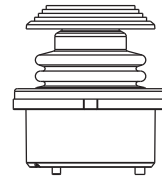

BUTTON STYLE 7
(LONG CONCAVE Y AXIS BUTTON)
(AVAILABLE FOR HTL2 ONLY)

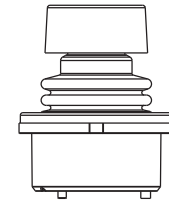

BUTTON STYLE 8
(LOW PROFILE BUTTON)
(AVAILABLE FOR HTL2 ONLY)

