

SHORTER BEHIND PANEL DEPTH



Knurled
Wheel



Paddle
Wheel

The HTWM offers the same performance as the standard HTW Proportional Thumbwheel but with a much shorter behind panel depth, ideal for use in grip, armrest and panel applications. Available with eight output options, the HTWM offers a spring return-to-center, single axis thumbwheel actuator that provides linear change in voltage output in either direction from center. Options include increasing or decreasing voltage output from the center position to the full travel position, and single or dual (redundant) outputs per axis. The HTWM offers snap-in style mounting and a three million cycle rotational life. The HTWM electronics are sealed to IP68S and have excellent EMI/RFI immunity.

Features:

- Shorter behind panel depth: 0.96" max.
- 8 output options
- Spring return-to-center single axis actuator
- Rocker switch style mounting
- 3 million cycle rotational life
- Electronics sealed to IP68S
- Excellent EMI/RFI immunity
- Tighter center tolerance options
- RoHS compliant

Standard Characteristics/Ratings:

MECHANICAL:

Mechanical Life: 3,000,000 full forward to full back

Max Allowable Radial Load: 30.0 lbs.

ELECTRICAL RATINGS: Rated at Vcc = 5V @ 25°C Load = 1mA (4.7KΩ)

Electrical	Units	Min	Typ	Max
Supply Voltage	VDC	4.50	5.00	5.50
Output Voltage Tolerance at Center (A, B, C, D, E, F and G)	VDC @ 5V Vcc	-0.25	N/A	+0.25
Output Voltage Tolerance at Center (J, K, L, M, N and P)	VDC @ 5V Vcc	-0.15	N/A	+0.15
Output Voltage Tolerance at Full Travel	VDC @ 5V Vcc	-0.25	N/A	+0.25
Supply Current Per Sensor	mA	N/A	N/A	10

ELECTRONICS:

Seal Integrity: Electronics IP68S

ENVIRONMENTAL:

Operating Temp Range: -40°C to +85°C

Humidity: 96% RH, 70°C, 96 hours

Vibration: Per MIL-810F minimum integrity

EMI: Withstand per SAE J1113

RFI: Withstand per SAE J1113

MATERIALS:

Button: Thermoplastic

Bezel: Thermoplastic

Wires: 18 AWG or 22 AWG

Ihr offizieller Vertriebspartner



ALDERS[®]
Indicate. Control. Connect.

ALDERS electronic GmbH

Arnoldstraße 19
47906 Kempen

+49 2152 8955-0

vertrieb@alders.de / www.alders.de

MINI PROPORTIONAL OUTPUT THUMBWHEEL

SHORTER BEHIND PANEL DEPTH

HTWM PART NUMBER CODE

HTWM	-	X	X	X	X	X	X	X
Travel	Output 1*	Output 2**	Operating Force	Button Style	Termination	Bezel Color	Button Color	
1. +/- 40°	A. 2.5 +/- 2.0VDC	NONE	1.5.0 oz.	1. Knurled Wheel	A. 18 AWG Wires, 18.3" Long, Stripped Ends	1. Red	1. Red	
	B. 2.5 +/- 2.0VDC	2.5 +/- 2.0VDC		2. Paddle Wheel	C. 22 AWG Wires, 18.5" Long, Stripped Ends	2. Black	2. Black	
	C. 2.5 +/- 2.0VDC	2.5 -/+ 2.0VDC				3. Orange	3. Orange	
	D. 2.5 +/- 1.5VDC	NONE				4. Yellow	4. Yellow	
	E. 2.5 +/- 1.5VDC	2.5 +/- 1.5VDC				5. Green	5. Green	
	F. 2.5 +/- 1.5VDC	2.5 -/+ 1.5VDC				6. Blue	6. Blue	
	G. 1.0 - 4.0VDC	1.0 - 4.0VDC				7. Violet	7. Violet	
	H. 0.5 - 4.5VDC	0.5 - 4.5VDC				8. Gray	8. Gray	
	J. 2.5 +/- 2.0VDC	NONE***				9. White	9. White	
	K. 2.5 +/- 2.0VDC	2.5 +/- 2.0VDC***						
	L. 2.5 +/- 2.0VDC	2.5 -/+ 2.0VDC***						
	M. 2.5 +/- 1.5VDC	NONE***						
	N. 2.5 +/- 1.5VDC	2.5 +/- 1.5VDC***						
	P. 2.5 +/- 1.5VDC	2.5 -/+ 1.5VDC***						

* Outputs are from the center position to the full travel position in each direction. Options A-F provide increasing voltage in Direction 1 and decreasing voltage in Direction 2 from a single output. Options G and H provide increasing voltages in both directions from two separate outputs.

** Options B and E provide redundant output 2 which duplicates output 1. Options C and F provide redundant output 2 which is inverse of output 1.

*** Options J, K, L, M, N and P are identical to options A, B, C, D, E and F respectively, except with a tighter center tolerance.

HTWM Knurled Wheel Style Thumbwheel Shown

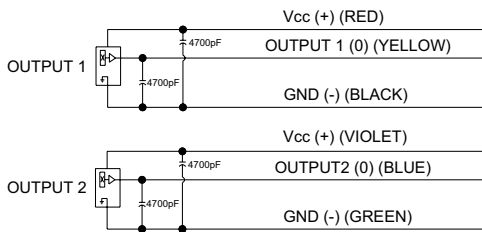
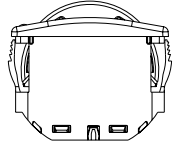
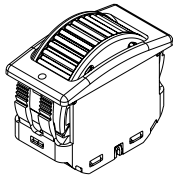

OUTPUT 2 IS NOT PRESENT IN ALL CONFIGURATIONS

MOUNTING:

RECOMMENDED PANEL THICKNESS: 0.150 OPTIMUM THICKNESS
(0.040 MIN. - 0.200 MAX.)

RECOMMENDED PANEL OPENING: 0.700 X 1.340 OPTIMUM
(0.695/0.705 X 1.335/1.345)

RECOMMENDED PANEL RADII: 0.100 OPTIMUM
(0.090 - 0.110 MAX.)

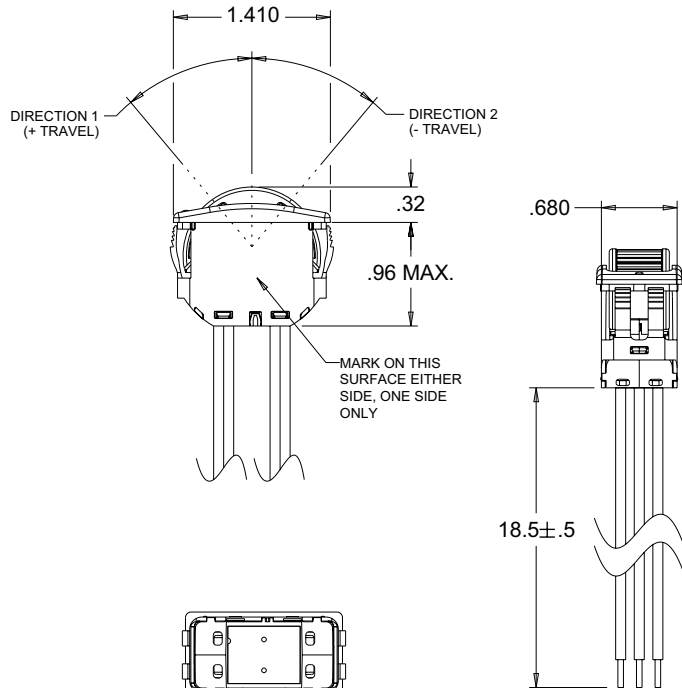
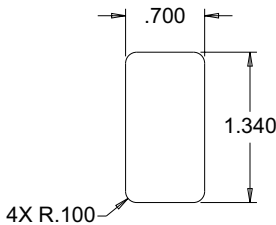

NOT ALL WIRES ARE PRESENT
IN ALL OUTPUT CONFIGURATIONS

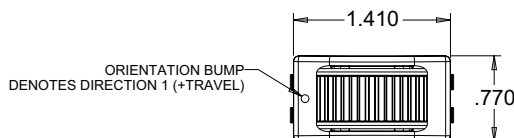

SHORTER BEHIND PANEL DEPTH

OPTION A & J

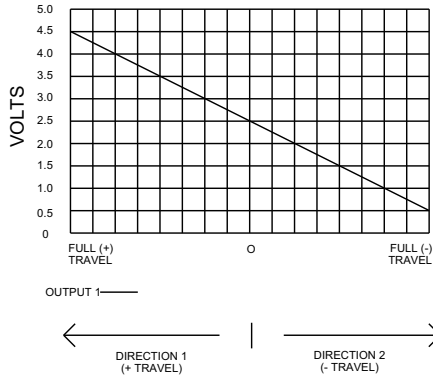

OPTION B & K

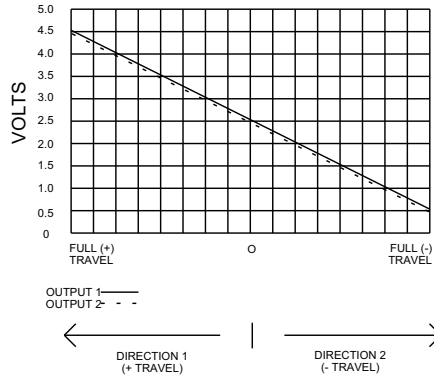

OPTION C & L

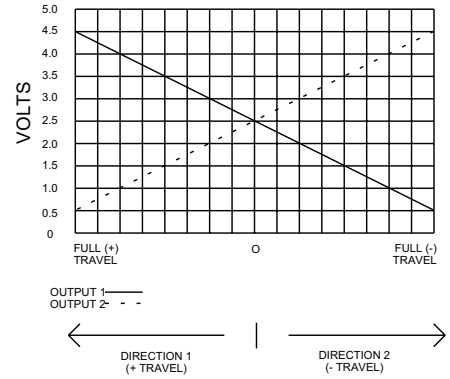

OPTION D & M

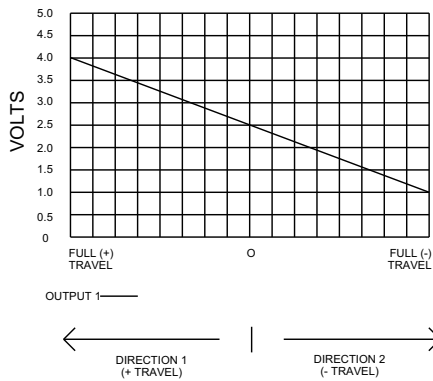

OPTION E & N

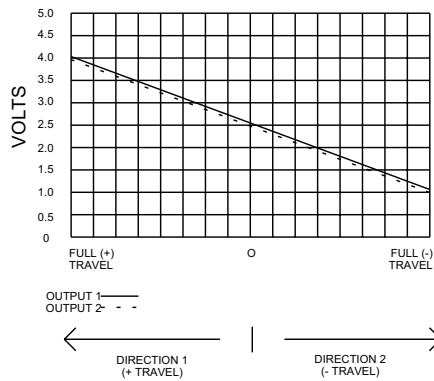

OPTION F & P

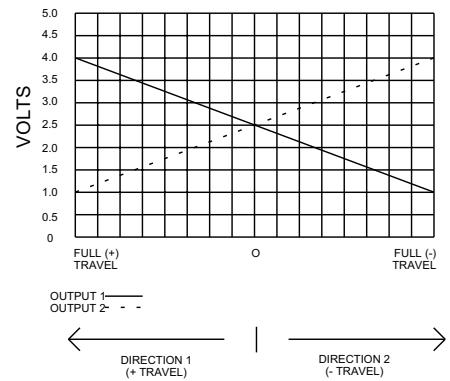

OPTION G

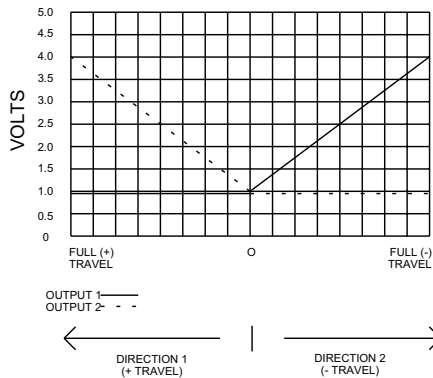

OPTION H

