

PROPORTIONAL OUTPUT THUMBWHEEL

HTWS
SUBMINIATURE
THUMBWHEEL

SUBMINIATURE PROPORTIONAL OUTPUT THUMBWHEEL

The HTWS Hall Effect Proportional Output Thumbwheel is a smaller version of OTTO's HTW and HTWM. It is a spring return-to-center, single axis thumbwheel that provides a linear change in voltage output corresponding to actuator movement in either direction from center. Its smaller size makes it a perfect choice for use in grips or panels where space is limited. The HTWS is available with eight output options, including increasing and decreasing voltage output from the center position to the full travel position and single or dual (redundant) outputs.

The HTWS snaps into a 0.895" x 0.420" panel opening. Electronics are sealed to IP68S, and an optional sealing boot is offered for added protection against dust, sand, and water ingress. The HTWS offers a three million cycle rotational life, operate force options and excellent EMI /RFI immunity. It is available with flying wire leads or pin connection.

Features:

- 8 output options
- Spring return-to-center single axis actuator
- Installs into 0.895" x 0.420" panel opening
- Integrated snap-in retaining feature
- Sealing boot option
- 3 million cycle rotational life
- Electronics sealed to IP68S
- Excellent EMI/RFI immunity
- Flow through design
- RoHS compliant



Ihr offizieller Repräsentant
Your official representative
ALDERS electronic GmbH
Arnoldstraße 19
47906 Kempen · Germany
+49 2152 8955-0
vertrieb@alders.de



Standard Characteristics/Ratings:				
ELECTRICAL RATINGS: Rated at 5V @ 25°C Load = 1mA (4.7KΩ)				
Electrical	Units	Min	Typ	Max
Supply Voltage	VDC	4.5	5.0	5.5
Output Voltage	VDC	-25	N/A	+25
Tolerance at Center	@ 5V Vcc			
Output Voltage	VDC	-25	N/A	+25
Tolerance Full Travel	@ 5V Vcc			
Supply Current Per Sensor	mA	N/A	N/A	10
MECHANICAL:				
Mechanical Life:	3,000,000 full forward to full back (button styles 1, 2) 1,000,000 full forward to full back (button style 3)			
Max Allowable Radial Load:	15.0 lbs. (button styles 1, 2); 10.0 lbs (button style 3)			
ENVIRONMENTAL:				
Operating Temp Range:	-40°C to +85°C			
Humidity:	96% RH, 70°C, 96 hours			
Vibration:	Per MIL-810F minimum integrity			
Electronics Enclosure:	IP68S			
Mechanical Enclosure:	Unsealed (button styles 1,2)			
Mechanical Enclosure:	IP64 (button style 3) (above panel)			
Mechanical Enclosure:	Unsealed (button style 3) (below panel)			
EMI/RFI:	Withstand per SAE J1113			
MATERIALS:				
Button Top:	Thermoplastic			
Bezel:	Thermoplastic			
Boot:	Silicone Rubber, Black			

HTWS PROPORTIONAL THUMBWHEEL PART NUMBER CODE

HTWS	-	X	X*	X	X	X	X****	X*****
Travel	Output 1	Output 2	Operating Force	Button Style	Termination	Bezel Color	Button Color	
1. +/-30°	A. 2.5 +/- 2.0VDC	NONE	1. 5 oz. typ.	1. Knurled Wheel	A. Wire Leads, 22 AWG UL 1569 (Separate Power and Ground)**	1. Red	1. Red	
2. +/-45°	B. 2.5 +/- 2.0VDC	2.5 +/- 2.0VDC	2. 8.5 oz. typ.	2. Paddle Wheel	B. Wire Leads, 22 AWG UL 1569, (Common Power and Ground)***	2. Black	2. Black	
	C. 2.5 +/- 2.0VDC	2.5 +/- 2.0VDC	3. 12 oz. typ.	3. Paddle Wheel with Seal Boot		3. Orange	3. Orange	
	D. 2.5 +/- 1.5VDC	NONE					4. Yellow	
	E. 2.5 +/- 1.5VDC	2.5 +/- 1.5VDC					5. Green	
	F. 2.5 +/- 1.5VDC	2.5 +/- 1.5VDC					6. Blue	
	G. 1.0 - 4.0VDC	1.0 - 4.0VDC					7. Violet	
	H. 0.5 - 4.5VDC	0.5 - 4.5VDC					8. Gray	
							9. White	

* Outputs are from the center position to the full travel position in each direction
Options "A" "B" "C" "D" "E" "F" provide increasing voltage in direction 1 and decreasing voltage in direction 2 from a single output.
Option "G" and "H" provide increasing voltages in both directions from two separate outputs.
Option "B" and "E" provide redundant output 2 which duplicates output 1. Option "C" and "F" provide redundant output 2 which is inverse of output 1
** Only available with output options B, C, E, F, G and H.
*** For single output switches, termination option "B" should not be selected.
**** Contact Factory for more details.
***** Minimums may apply to colors other than red and black.

SUBMINIATURE PROPORTIONAL OUTPUT THUMBWHEEL

HTWS Paddle Wheel Style Shown

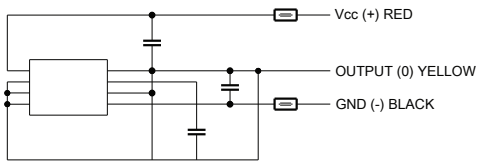
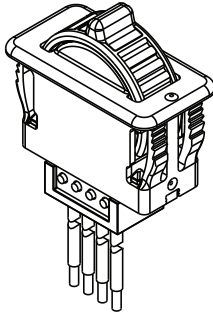

SINGLE OUTPUT SCHEMATIC

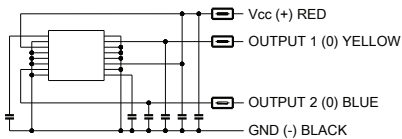

DUAL OUTPUT
COMMON POWER & GROUND
SCHEMATIC

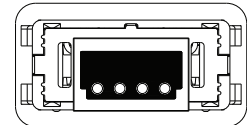
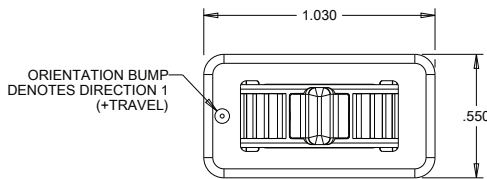
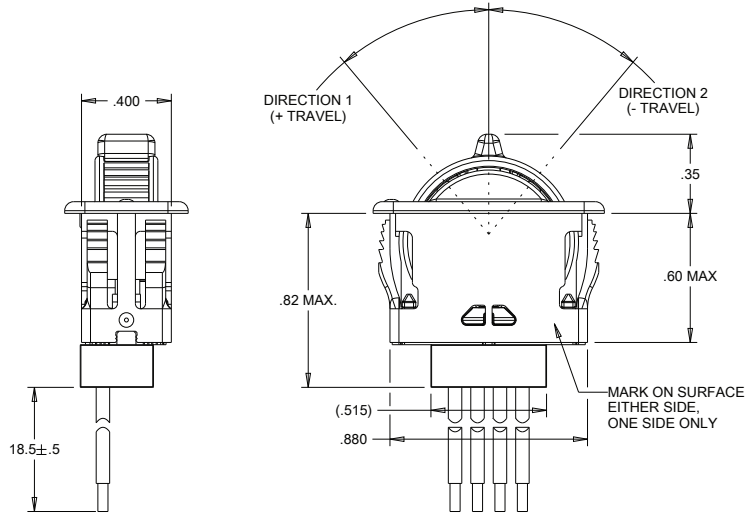

NOT ALL WIRES ARE PRESENT
IN ALL OUTPUT CONFIGURATIONS

MOUNTING:
RECOMMENDED PANEL THICKNESS: 0.150 OPTIMUM THICKNESS

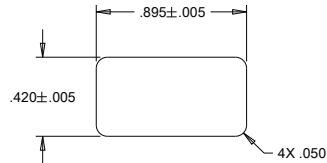

HTWS Paddle Wheel with Boot Style Shown

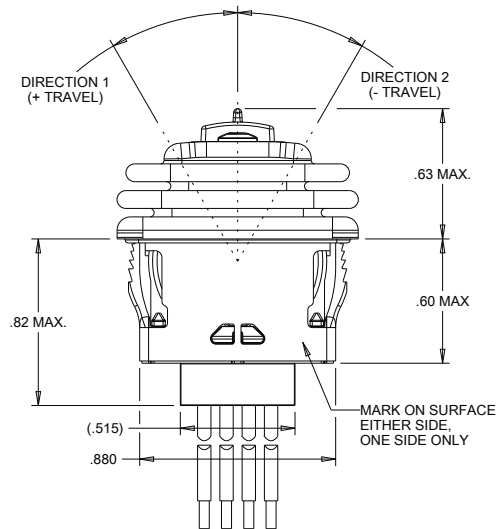
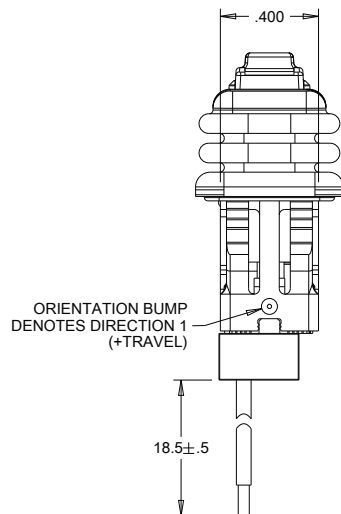
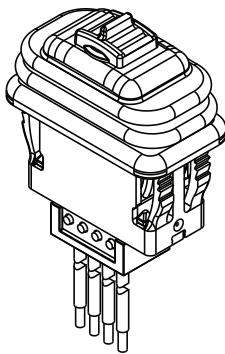

PROPORTIONAL OUTPUT THUMBWHEEL

SUBMINIATURE PROPORTIONAL OUTPUT THUMBWHEEL

OPTION A

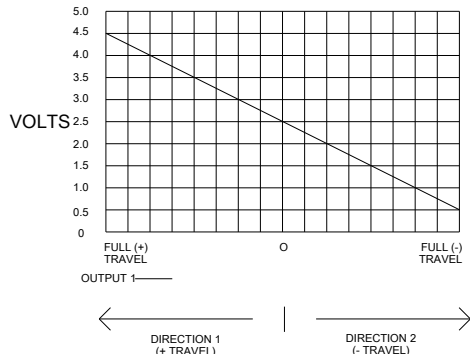

OPTION B

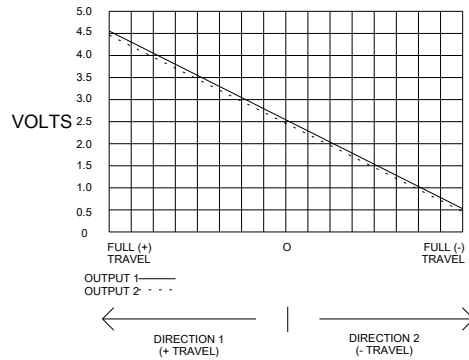

OPTION C

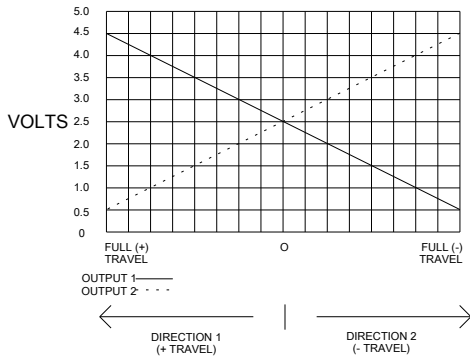

OPTION D

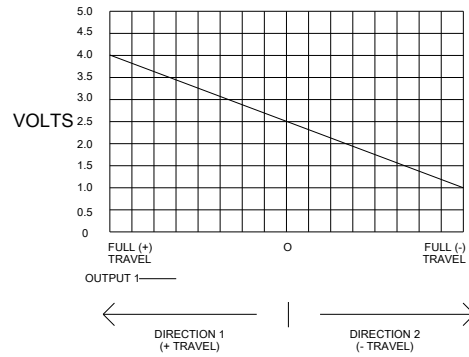

OPTION E

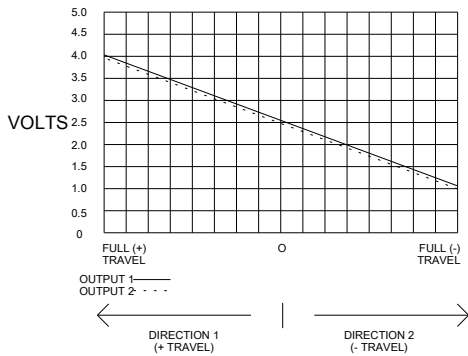

OPTION F

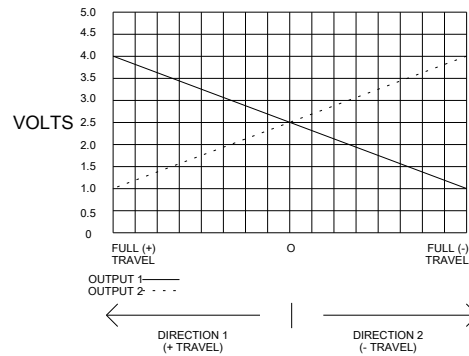

OPTION G

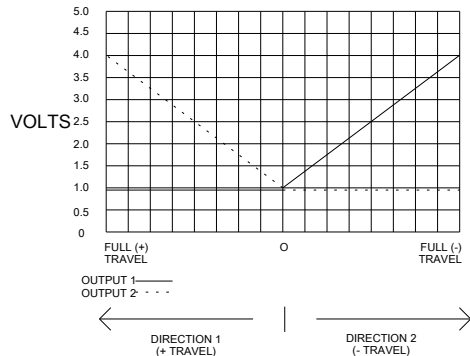

OPTION H

