

3 MILLION CYCLE ROTATIONAL LIFE



Knurled Wheel
(with Wires)



PaddleWheel
(with Pins)

The HTW Hall Effect Proportional Output Thumbwheel is a spring return-to-center, single axis thumbwheel with an actuator that provides linear change in voltage output in either direction from the center. Available with eight output options, including increasing and decreasing voltage output from the center position to the full travel position and single or dual (redundant) outputs. The HTW snaps into a 1.47" x 0.710" panel opening with rocker switch style mounting. A durable switch providing three million cycle rotational life, sealed to IP68S and excellent EMI/RFI immunity.

Features:

- 14 output options
- Spring return-to-center single axis actuator
- Snaps into 1.47" x 0.710" panel opening
- Rocker switch style mounting
- 3 million cycle rotational life
- Electronics sealed to IP68S
- Excellent EMI/RFI immunity
- Detent options available
- Tighter center tolerance options
- RoHS compliant

Your official representative



ALDERS
Indicate. Control. Connect.

ALDERS electronic GmbH
Arnoldstraße 19
47906 Kempen - Germany

+49 2152 8955-0
sales@alders.de / www.alders.de

Standard Characteristics/Ratings:

MECHANICAL:

Mechanical Life: 3,000,000 full forward to full back

Mechanical Detent Cycle Life Per Detent: 100,000 (detent @ +/- 21°, full travel is +/- 30° max)

Max Allowable Radial Load: 30.0 lbs.

ELECTRICAL RATINGS: Rated at Vcc = 5V @ 25°C Load = 1mA (4.7KΩ)

Electrical	Units	Min	Typ	Max
Supply Voltage	VDC	4.50	5	5.50
Output Voltage Tolerance at Center (A, B, C, D, E, F, G and H)	VDC @ 5V Vcc	-0.15	N/A	+0.15
Output Voltage Tolerance at Center (J, K, L, M, N and P)	VDC @ 5V Vcc	-0.10	N/A	+0.10
Output Voltage Tolerance at Center (for detent version A only)	VDC @ 5V Vcc	-0.25	N/A	+0.25
Output Voltage Tolerance Full Travel	VDC @ 5V Vcc	-0.25	N/A	+0.25
Supply Current Options A & D B=0, Vcc=5V, Iout=0	mA	N/A	N/A	10
Supply Current For all Other Options B=0, Vcc=5V, Iout=0	mA	N/A	N/A	20

Reverse Voltage Protection: -5VDC max

ELECTRONICS:

Seal Integrity: Electronics IP68S

ENVIRONMENTAL:

Operating Temp Range: -40°C to +85°C

Humidity: 96% RH, 70°C, 96 hours

Vibration: Per MIL-810F minimum integrity

EMI: Withstand per SAE J1113

RFI: Withstand per SAE J1113

MATERIALS:

Button: Thermoplastic

Bezel: Thermoplastic

Snap Arms: Stainless steel

Wires: 18 AWG

PROPORTIONAL OUTPUT THUMBWHEEL

3 MILLION CYCLE ROTATIONAL LIFE

HTW PART NUMBER CODE

HTW	-	X	X	X	X	X	X	X	X
Travel	Output 1	Output 2	Operating Force	Button Style	Termination	Bezel Color	Button Color	Detent (if required)*	
1. +/- 40°	A. 2.5 +/- 2.0VDC	NONE	1. 5.0 oz.	1. Knurled Wheel	A. 18 AWG Wires 18.3" Long, Stripped Ends	1. Red	1. Red	A. Spring return center +/- 21°. 12 oz detent at end of travel, both directions**	
2. +/- 30°	B. 2.5 +/- 2.0VDC	2.5 +/- 2.0VDC		2. Paddle Wheel	B. 0.025" SQ. Pins	2. Black	2. Black		
	C. 2.5 +/- 2.0VDC	2.5 +/- 2.0VDC				3. Orange	3. Orange		
	D. 2.5 +/- 1.5VDC	NONE				4. Yellow	4. Yellow		
	E. 2.5 +/- 1.5VDC	2.5 +/- 1.5VDC				5. Green	5. Green		
	F. 2.5 +/- 1.5VDC	2.5 +/- 1.5VDC				6. Blue	6. Blue		
	G. 1.0 - 4.0VDC	1.0 - 4.0VDC				7. Violet	7. Violet		
	H. 0.5 - 4.5VDC	0.5 - 4.5VDC				8. Gray	8. Gray		
	J. 2.5 +/- 2.0VDC	NONE***				9. White	9. White		
	K. 2.5 +/- 2.0VDC	2.5 +/- 2.0VDC***							
	L. 2.5 +/- 2.0VDC	2.5 +/- 2.0VDC***							
	M. 2.5 +/- 1.5VDC	NONE***							
	N. 2.5 +/- 1.5VDC	2.5 +/- 1.5VDC***							
	P. 2.5 +/- 1.5VDC	2.5 +/- 1.5VDC***							

* Detented switch full travel is ±30° max. Detented switches reach full output before engaging detents.

** Only available with Travel option 2.

*** Options J, K, L, M, N and P are identical to options A, B, C, D, E and F respectively, except with a tighter center tolerance.

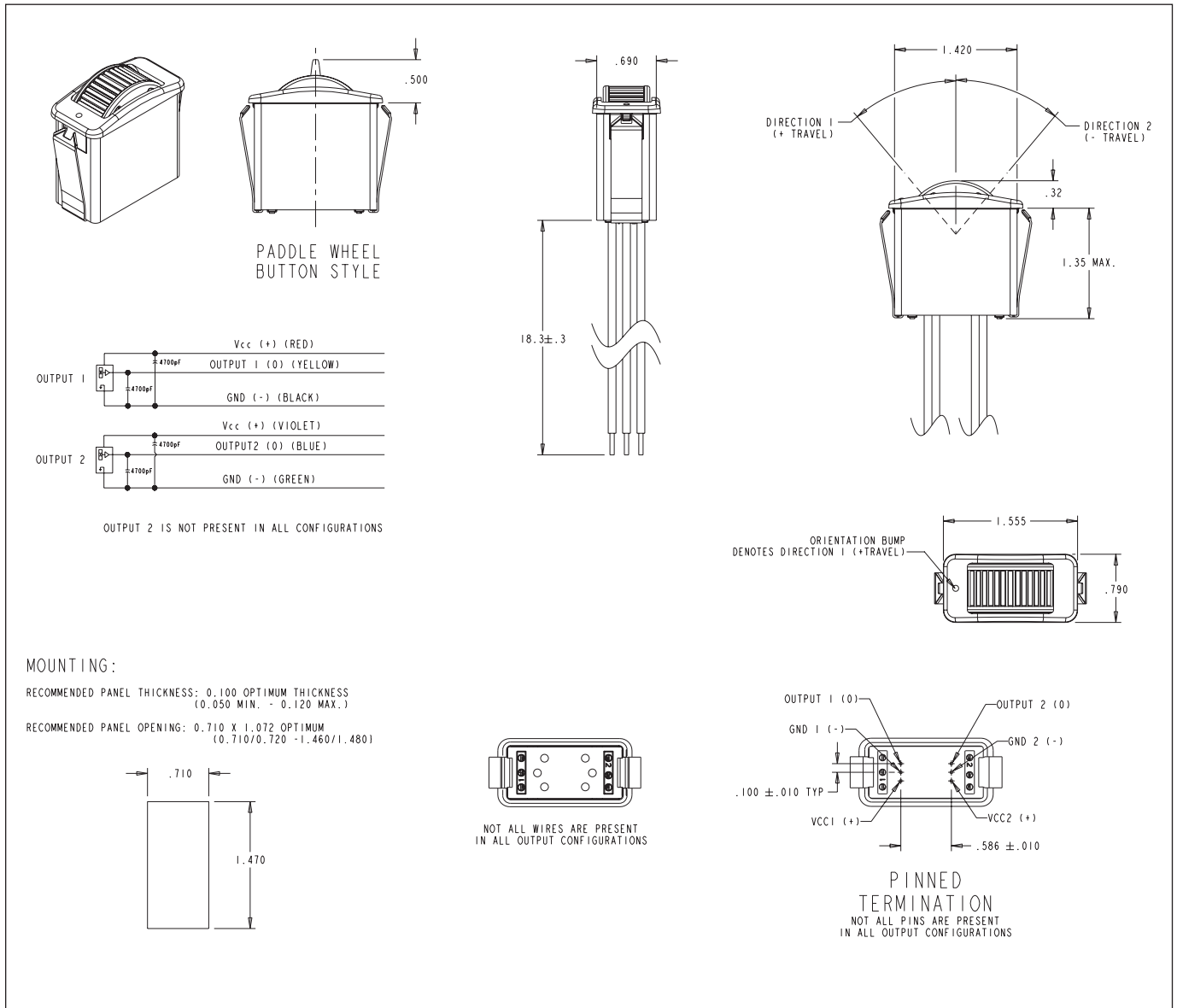

3 MILLION CYCLE ROTATIONAL LIFE

OPTION A & J

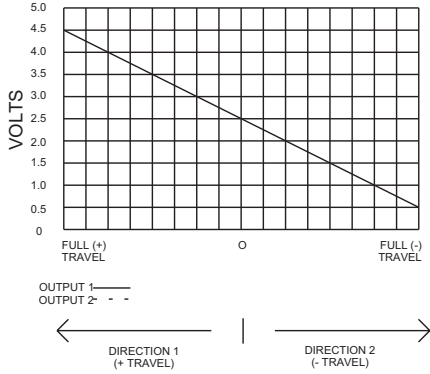

OPTION B & K

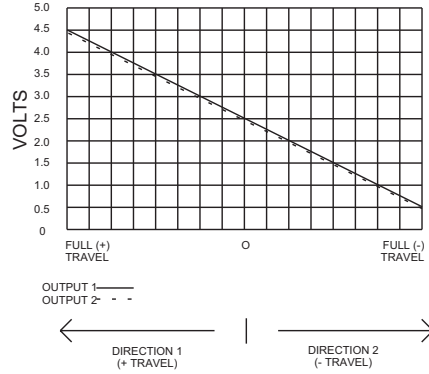

OPTION C & L

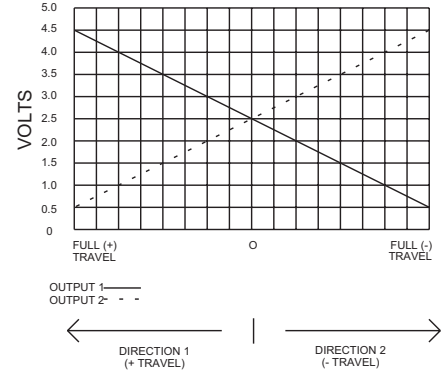

OPTION D & M

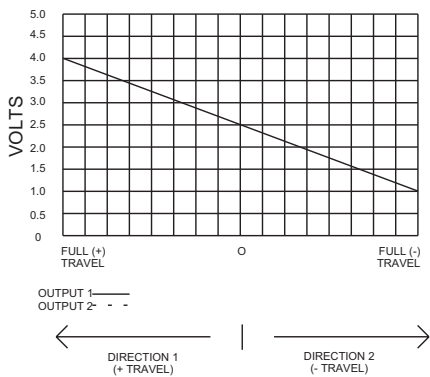

OPTION E & N

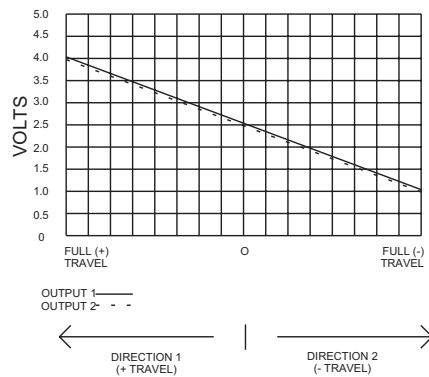

OPTION F & P

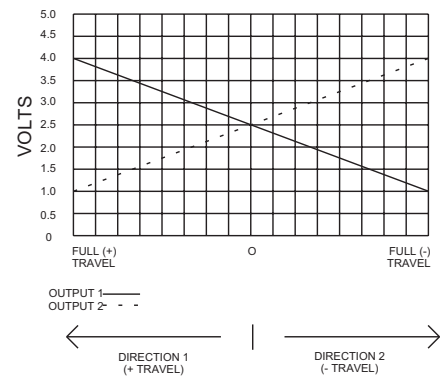

OPTION G

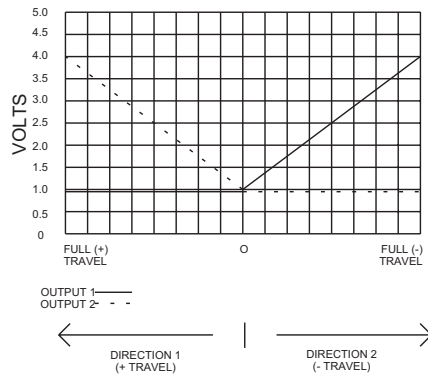

OPTION H

