

# SEALED SWITCH MODULE

SELF-CONTAINED, LONG-LIFE, SEALED SWITCH MODULE WITH UP TO 5 POSITIONS

The TC is a self contained, sealed switch module with up to 5 positions. It can be utilized in numerous applications that require a compact switch module and long life.

At slightly over an inch in diameter, it can be used in a grip, front panel, or hand held device, just to name a few applications. It is available in either a top mount or rear mount.

The advantage of the TC switch module is that it incorporates keypad functionality within a very small footprint. Standard or custom legends are available and can be LED backlit.

Standard termination options include FPC, flying leads, ribbon cable (with or without AMP connector) and FFC (flexible flat cable). Tested to three million cycles, the TC switch module has an operating temperature range of -40°C to 85°C and it is sealed to IP68S.

The TC can be used in panel or grip applications and is especially useful in cursor control or data entry applications. Applications include construction, agriculture, industrial, material handling and medical.

## Features:

- Watertight to IP68S
- Great for grips and panels
- 3 million cycle electrical life
- LED backlight option



TC Standard Characteristics/Ratings:	
<b>ELECTRICAL RATINGS:</b>	1-28 VDC @ Sea Level
<b>Load:</b>	10-100mA Resistive
<b>Electrical Life:</b>	3,000,000 cycles
<b>LED Voltage Rating:</b>	2.0 VDC
<b>Mechanical Life:</b>	3,000,000 cycles
<b>Seal:</b>	IP68S
<b>Operating Temp Range:</b>	-40°C to +85°C
<b>Operating Force:</b>	1.0 +/- .5 lbs.
<b>Pushout Force:</b>	5 lbs. min.
<b>MATERIALS:</b>	
<b>Housing:</b>	PBT
<b>Keypad:</b>	Silicone Rubber
<b>Terminal Hardware:</b>	None provided
<b>Mounting Hardware:</b>	VHB tape



TC-5 with standard legend used in a Contour Grip

## TC Switch Module Keypad Configurations

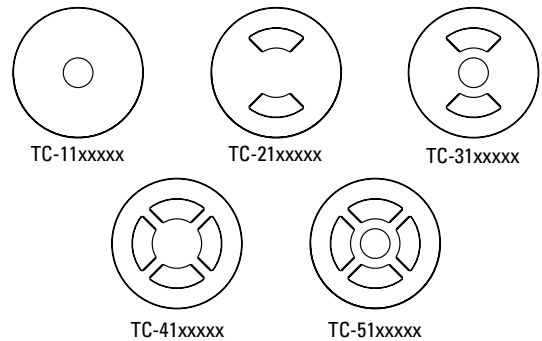

## TC PART NUMBER CODE

TC	-	X		X		X		X		X		X
<b>Position</b>		<b>Mounting</b>		<b>Termination</b>		<b>Backlight</b>		<b>Color</b>		<b>Legend*</b>		<b>Not Used</b>
1. 1 Position		1. Top Mount		1. FPC, UL 20798		N. None		2. Black		None		
2. 2 Position		2. Rear Mount (Behind Panel)		2. Flying Leads, UL 1569, 24 AWG		9. White				A. Arrows		
3. 3 Position				3. FFC, UL 20624								
4. 4 Position				4. Ribbon Cable, UL 2651, & AMP 215083-8 Connector								
5. 5 Position				5. Ribbon Cable, UL 2651, Blunt Cut								

### Arrow Legend Styles

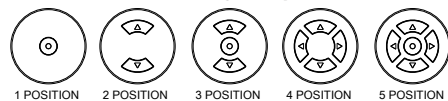

\* Color = White

Your official representative

**ALDERS**  
Indicate. Control. Connect.

ALDERS electronic GmbH  
Arnoldstraße 19  
47906 Kempen - Germany  
+49 2152 8955-0  
sales@alders.de / www.alders.de

# SEALED SWITCH MODULE

SELF-CONTAINED, LONG-LIFE, SEALED SWITCH MODULE WITH UP TO 5 POSITIONS

## TC-51xxxxx Top Mount, 5 Position Module

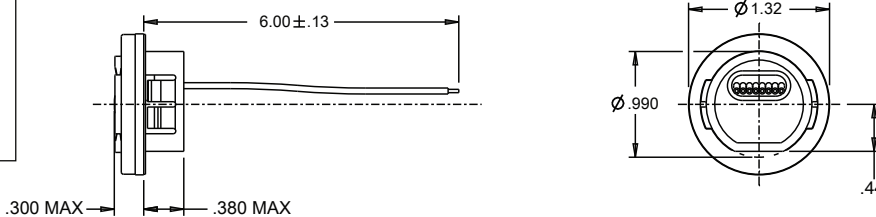
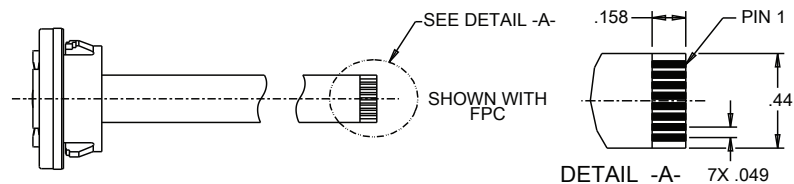
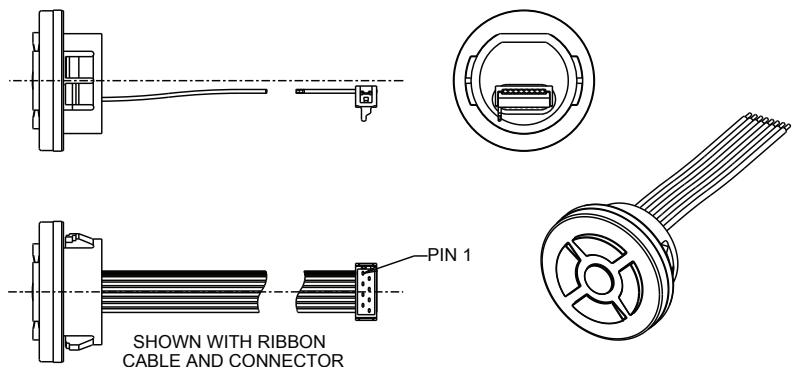
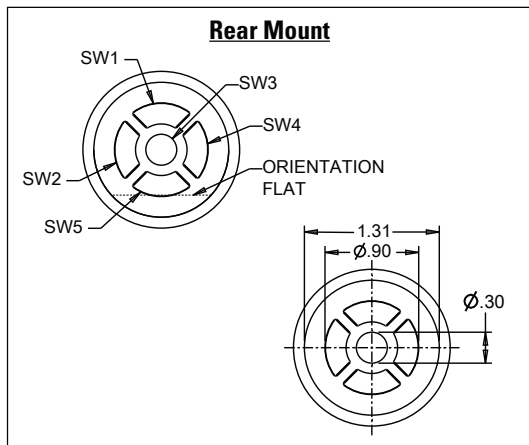
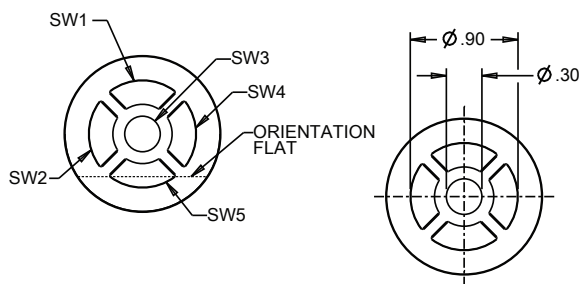

PANEL THICKNESS: ACCOMODATES  
PANEL THICKNESSES FROM  
.025 TO .100 WITH VHB TAPE SEAL,  
AND FROM .025 TO .125 WITHOUT  
VHB SEAL TAPE.

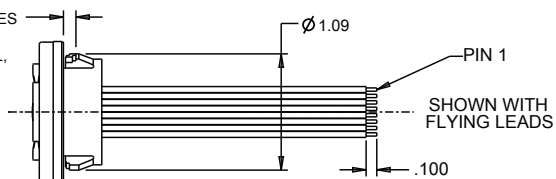

### Standard Legend Configurations

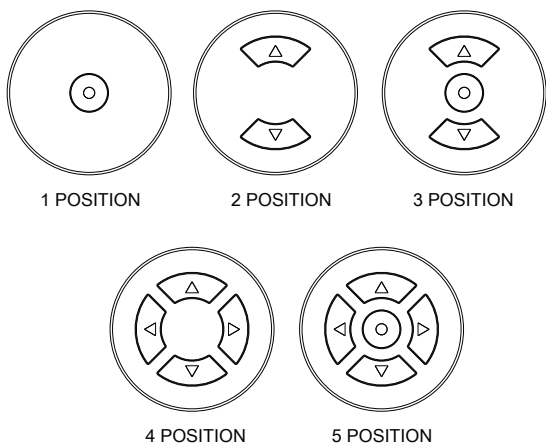

### Schematic with optional LED circuit shown

